





# PRICE LIST 2011

Please contact us for quantity discounts and the latest stock availability.  
Call 0845 124 9955 - Fax 0845 125 9955 or e-mail [sales@mipl.org.uk](mailto:sales@mipl.org.uk)



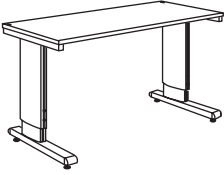
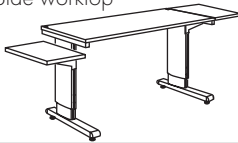
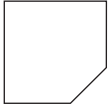

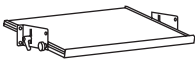
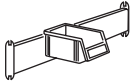
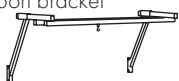

**Merlin**  
Industrial Products Ltd

# Adjustable bench series WB

Product	Code	Height adjustment	Worktop D x W mm	Standard equipment	Price each £
	WB 811	Allen key	800 x 1073		483.00
	WB 815		800 x 1500		495.00
	WB 818		800 x 1800		515.00
	WB 811 C*	Retractable handle	800 x 1073	Cable tidy	1,010.00
	WB 815 C		800 x 1500	Cable tidy	1,030.00
	WB 818 C		800 x 1800	Cable tidy	1,070.00
	WB 811 EL *	Electric motor	800 x 1073	Cable tidy	1,490.00
	WB 815 EL		800 x 1500	Cable tidy	1,530.00
	WB 818 EL		800 x 1800	Cable tidy	1,560.00
	WB 811 ESD	Allen key	800 x 1073		580.00
	WB 815 ESD		800 x 1500		595.00
	WB 818 ESD		800 x 1800		680.00
	WB 811 C ESD*	Retractable handle	800 x 1073	Cable tidy	1,060.00
	WB 815 C ESD		800 x 1500	Cable tidy	1,100.00
	WB 818 C ESD		800 x 1800	Cable tidy	1,170.00
	WB 811 EL ESD*	Electric motor	800 x 1073	Cable tidy	1,550.00
	WB 815 EL ESD		800 x 1500	Cable tidy	1,580.00
	WB 818 EL ESD		800 x 1800	Cable tidy	1,700.00
	WB 804 ST		800 x 400		93.00
	WB 804 ST ESD		800 x 400		132.00
	WB 1212 CT	Allen key	1153 x 1153		192.00
	WB 1212 CT ESD		1153 x 1153		343.00
	CTR 705	Allen key	700 x 500	Lower shelf	330.00
	CTR 705 ESD		700 x 500	Lower shelf	440.00
		Dimensions	Construction	Suitable for	
	AL2X 110W	1063 x 900	with 3 cable clips	WB 811	145.00
	AL2X 150W	1489 x 900	with 3 cable clips	WB 815	147.00
	AL2X 180W	1789 x 900	with 3 cable clips	WB 818	156.00
	AKK 150	1419 x 500		WB 815	82.00
	AKK 180	1719 x 500		WB 818	96.00
	ALH 110	310 x 1073		WB 811	109.00
	ALH 150	310 x 1500		WB 815	144.00
	ALH 180	310 x 1800		WB 818	159.00
	ALH 110 ESD	310 x 1073		WB 811 ESD	192.00
	ALH 150 ESD	310 x 1500		WB 815 ESD	228.00
	ALH 180 ESD	310 x 1800		WB 818 ESD	239.00
	ASH 70	400 x 660		WB 815/WB 818	107.00
	ASH 100	400 x 960		WB 811/WB 818	119.00
	ASH 70 ESD	400 x 660		WB 815/WB 818 ESD	156.00
	ASH 100 ESD	400 x 960		WB 811/WB 818 ESD	192.00
	BP 70	length 685		WB 815 /WB 818	40.00
	BP 100	length 985		WB 811/WB 818	45.00
	BP 70 ESD	length 685		WB 815/WB 818 ESD	48.00
	BP 100 ESD	length 985		WB 811/WB 818 ESD	53.00
	HSB 110	length 1073	steel	WB 811	108.00
	HSB 150	length 1500	steel	WB 815	111.00
	HSB 180	length 1800	steel	WB 818	119.00

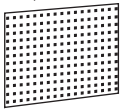
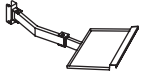
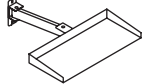
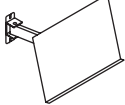
\*] Made to order only.

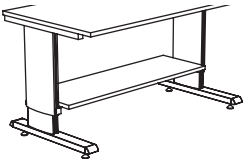
# Adjustable bench series WB

Product	Code	Dimensions	Suitable for	Price each £	
Perforated panel 	ARL 70	500 x 667 mm	WB 815/818	58.00	
	ARL 100	500 x 967 mm	WB 811/818	72.00	
Swivel arm with tray 	AKV 400	210 x 460 mm	WB	150.00	
	AKV 400 ESD	210 x 460 mm	WB ESD	182.00	
Keyboard shelf 	WKA	220 x 500 mm	WB	100.00	
	WKA ESD	220 x 500 mm	WB ESD	115.00	
Document stand 	WDA	440 x 300 mm	WB	105.00	
	WDA ESD	440 x 300 mm	WB ESD	111.00	
Cable tidy 	WBCT 110*	64 x 204 x 948 mm	WB 811/ WB 811 ESD	53.00	
	WBCT 150	64 x 204 x 1375 mm	WB 815/ WB 815 ESD	57.00	
	WBCT 180	64 x 204 x 1675 mm	WB 818/ WB 818 ESD	61.00	
Cable clip set	CC 8	Set = 5 pieces	WB/ ESD	8.90	
Lower shelf 	AT 110 WB*	400 x 828 mm	WB 811	POA	
	AT 150 WB*	400 x 1255 mm	WB 815	POA	
	AT 180 WB*	400 x 1555 mm	WB 818	POA	
	AT 110 WB ESD*	400 x 828 mm	WB 811 ESD	POA	
	AT 150 WB ESD*	400 x 1255 mm	WB 815 ESD	POA	
	AT 180 WB ESD*	400 x 1555 mm	WB 818 ESD	POA	
Electrical trunking kit 	TJK 904	profile 931 mm	With 4 switched single sockets. Compact aluminium profile. Wired, tested and ready to use.	WB 811/818/ ESD	184.00
	TJK 1504	profile 1358 mm		WB 815/ ESD	194.00
	TJK 1804	profile 1658 mm		WB 818/ ESD	205.00
Electrical trunking 	CJK 70	profile 631 mm	Made to order using your choice of components listed below. Compact aluminium profile. Will be wired, tested and ready to use.	WB 815/818/ ESD	116.00
	CJK 100	profile 931 mm		WB 811/818/ ESD	137.00
COMPONENTS:					
Single socket and switch	E2 GB	13 A		17.00	
Data connector	E6 GB	RJ 45 shielded for cat. 6 cable, not wired.		24.00	
Isolating switch	E9	on-off		POA	
Telephone socket	ETEL-2	BT secondary outlet, not wired.		19.00	

# Tilt adjustable workbench series WB TILT

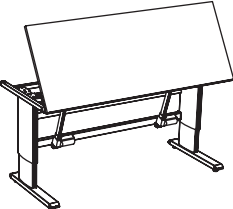
Product	Code.	Tilt adjustment	Height adjustment	Worktop D x W mm	Price each £
Tilt workbench 	WB 815 TILT*	Allen key	Allen key	800 x 1500 mm	POA
	WB 815 TILT C*	Retractable handle	Allen key	800 x 1500 mm	POA
	WB 815 TILT EL*	Electric motor	Allen key	800 x 1500 mm	POA
	WB 815 TILT ESD*	Allen key	Allen key	800 x 1500 mm	POA
	WB 815 TILT C ESD*	Retractable handle	Allen key	800 x 1500 mm	POA
	WB 815 TILT EL ESD*	Electric motor	Allen key	800 x 1500 mm	POA





\*) Made to order only.

# Workbench series TP/TPH/SAP

Product	Code	Height adjustment	Worktop D x W mm	Suitable for	Price each £
	TP 507	Allen key	500 x 700		197.00
	TP 510	Allen key	500 x 1000		217.00
	TP 515	Allen key	500 x 1500		259.00
	TP 710	Allen key	700 x 1000		240.00
	TP 712	Allen key	700 x 1200		248.00
	TP 715	Allen key	700 x 1500		270.00
	TP 718	Allen key	700 x 1800		300.00
	TP 915	Allen key	900 x 1500		306.00
	TP 918	Allen key	900 x 1800		334.00
	TP 507 ESD *	Allen key	500 x 700		218.00
	TP 510 ESD	Allen key	500 x 1000		262.00
	TP 515 ESD*	Allen key	500 x 1500		360.00
	TP 710 ESD	Allen key	700 x 1000		310.00
	TP 712 ESD	Allen key	700 x 1200		350.00
	TP 715 ESD	Allen key	700 x 1500		402.00
	TP 718 ESD	Allen key	700 x 1800		470.00
	TP 915 ESD	Allen key	900 x 1500		525.00
TP 918 ESD	Allen key	900 x 1800		586.00	
	TP 710L	Allen key	700 x 1000	TP 710 ... TP 718	200.00
	TP 712L	Allen key	700 x 1200	TP 710 ... TP 718	212.00
	TP 715L	Allen key	700 x 1500	TP 710 ... TP 718	239.00
	TP 718L	Allen key	700 x 1800	TP 710 ... TP 718	265.00
	TP 915L	Allen key	900 x 1500	TP 915 ... TP 918	266.00
	TP 918L	Allen key	900 x 1800	TP 915 ... TP 918	292.00
	TP 510K	Allen key	500 x 1000	TP/TPH/PPH	180.00
	TP 712K	Allen key	700 x 1200	TP/TPH/PPH	210.00
	TP 510K ESD	Allen key	500 x 1000	TP/TPH/PPH	244.00
	TPH 712	Allen key	700 x 1200		398.00
	TPH 715	Allen key	700 x 1500		420.00
	TPH 718	Allen key	700 x 1800		464.00
	TPH 915	Allen key	900 x 1500		458.00
	TPH 918	Allen key	900 x 1800		502.00
	TPH 712 ESD	Allen key	700 x 1200		538.00
	TPH 715 ESD	Allen key	700 x 1500		590.00
	TPH 718 ESD	Allen key	700 x 1800		698.00
	TPH 915 ESD	Allen key	900 x 1500		685.00
	TPH 918 ESD	Allen key	900 x 1800		819.00
	SAP 507	Allen key	500 x 700		232.00
	SAP 710	Allen key	700 x 1000		271.00
	SAP 715	Allen key	700 x 1500		318.00
	SAP 507 ESD	Allen key	500 x 700		279.00
	SAP 710 ESD	Allen key	700 x 1000		369.00
	SAP 715 ESD	Allen key	700 x 1500		469.00
	AT 507		500 x 700	SAP 507	51.00
	AT 710		700 x 1000	SAP 710	77.00
	AT 507 ESD		500 x 700	SAP 507 ESD	115.00
	AT 710 ESD		700 x 1000	SAP 710 ESD	209.00
Upright profiles	HKCP-147 **	2 pieces	height 1470	TPH	35.00
Stabilizer bracket	TPH-HT	pair		TPH	16.00

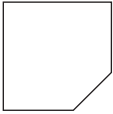

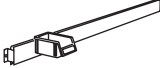
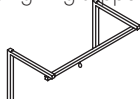
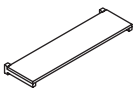
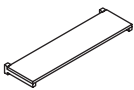
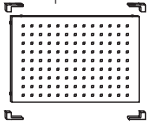
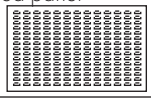
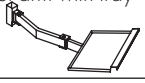
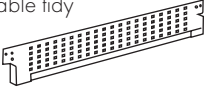

\*) Made to order only. \*\*) If you mount both perforated panel RL and cable channel TJK to TPH benches, you must order an extra-high upright profile HKCP-147.

# Accessories for TPH-workbenches



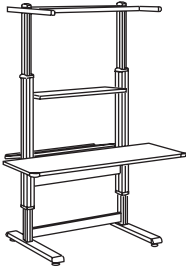

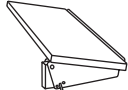
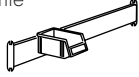
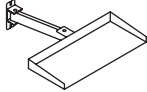
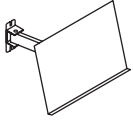
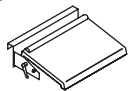
Product	Code	Dimensions D x W mm	Suitable for	Price each £	
Corner workbench 	TP 707 KK	1100 x 1100	TP 710... 718K	345.00	
	TP 909 KK	1300 x 1300	TP 915... 918K	379.00	
	TP 707 KK ESD	1100 x 1100	TP 710... 718K ESD	480.00	
	TP 909 KK ESD	1300 x 1300	TP 915... 918K ESD	562.00	
	TPH 707 KK	1100 x 1100	TPH 712... TPH 718	385.00	
	TPH 909 KK	1300 x 1300	TPH 915...TPH 918	405.00	
	TPH 707 KK ESD	1100 x 1100	TPH 712... TPH 718 ESD	528.00	
	TPH 909 KK ESD	1300 x 1300	TPH 915...TPH 918 ESD	584.00	
Metal shelf 	TH 120	145 x 1119	TPH 712	44.00	
	TH 150	145 x 1419	TPH 715/915	49.50	
	TH 180	145 x 1719	TPH 718/918	53.50	
	TH 120 ESD	145 x 1119	TPH 712 ESD	67.00	
	TH 150 ESD	145 x 1419	TPH 715/915 ESD	75.00	
	TH 180 ESD	145 x 1719	TPH 718/918 ESD	85.00	
	Bin profile 	BP 120	length 1115	TPH 712	44.00
BP 150		length 1415	TPH 715/915	50.50	
BP 180		length 1715	TPH 718/918	53.00	
BP 120 ESD		length 1115	TPH 712 ESD	51.60	
BP 150 ESD		length 1415	TPH 715/915 ESD	60.00	
BP 180 ESD		length 1715	TPH 718/918 ESD	62.00	
Tool and lighting support 	KT 120	length 1200	TPH 712	114.00	
	KT 150	length 1500	TPH 715/915	119.00	
	KT 180	length 1800	TPH 718/918	123.00	
Extra bar 	SPR 120*	length 1200	TPH 712	26.00	
	SPR 150	length 1500	TPH 715/915	32.00	
	SPR 180	length 1800	TPH 718/918	37.00	
Extra shelf 	SH 120	310 x 1200	TPH 712	108.00	
	SH 150	310 x 1500	TPH 715/915	115.00	
	SH 180	310 x 1800	TPH 718/918	119.00	
	SH 120 ESD	310 x 1200	TPH 712 ESD	169.00	
	SH 150 ESD	310 x 1500	TPH 715/915 ESD	185.00	
	SH 180 ESD	310 x 1800	TPH 718/918 ESD	209.00	
Perforated panel 	RL 120	1119 x 750	TPH 712	136.00	
	RL 150	1419 x 750	TPH 715/915	145.00	
	RL 180	1719 x 750	TPH 718/918	174.00	
Connectors	RK 1	needed to mount RL to TPH	RL/ TPH	21.00	
Louvred panel 	LP-1200	1120 x 450		51.00	
	LP-1500	1420 x 450		67.00	
	LP-1800	1720 x 450		78.00	
Swivel arm with tray 	CKV 400	210 x 460	C-profile	148.00	
	CKV 400 ESD	210 x 460	C-profile	165.00	
Cable tidy 	TPHCT 120	45 x 205 x 1115	TPH 712	89.00	
	TPHCT 150	45 x 205 x 1415	TPH 715/915	97.00	
	TPHCT 180	45 x 205 x 1715	TPH 718/918	103.00	
Cable clip set	CC 12	Set = 5 pieces	TPH	8.90	
Electrical trunking kit 	TJK 1204	profile 1058 mm	With 4 switched single sockets. Compact aluminium profile. Wired, tested and ready to use.	TP /TPH 712	184.00
	TJK 1504	profile 1358 mm		TP /TPH 715/915	194.00
	TJK 1804	profile 1658 mm		TP /TPH 718/918	205.00
Electrical trunking 	TJK 120	profile 1058 mm	Made to order using your choice of components listed below. Compact aluminium profile. Will be wired, tested and ready to use.	TPH 712	131.00
	TJK 150	profile 1358 mm		TPH 715/915	145.00
	TJK 180	profile 1658 mm		TPH 718/918	156.00
<b>COMPONENTS:</b>					
Single socket and switch	E2 GB	13 A		17.00	
Data connector	E6 GB	RJ 45 shielded for cat. 6 cable, not wired.		24.00	
Isolating switch	E9	on-off		POA	
Telephone socket	ETEL-2	BT secondary outlet, not wired.		19.00	

\*) Made to order only.

# Workstation series WS

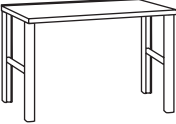
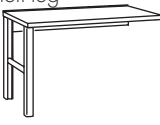
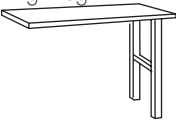
Product	Code	Height adjustment	Worktop D x W mm		Price each £
	WS 511	Allen key	550 x 1060		1,623.00
	WS 515		550 x 1500		1,726.00
	WS 511 C	Retractable handle	550 x 1060		2,576.00
	WS 515 C		550 x 1500		2,674.00
	WS 511 EL	Electric motor	550 x 1060		3,176.00
	WS 515 EL		550 x 1500		3,276.00
	WS 511 ESD	Allen key	550 x 1060		1,818.00
	WS 515 ESD		550 x 1500		2,070.00
	WS 511 C ESD	Retractable handle	550 x 1060		2,672.00
	WS 515 C ESD		550 x 1500		2,900.00
	WS 511 EL ESD	Electric motor	550 x 1060		3,480.00
	WS 515 EL ESD		550 x 1500		3,600.00
			Dimensions mm	Suitable for	
	WAS 90		400 x 870	WS 511/ 515	131.00
	WAS 90 ESD		400 x 870	WS 511/515 ESD	204.00
	WFS 90		310 x 900	WS 511/ 515	62.00
	WFS 90 ESD		310 x 900	WS 511/ 515 ESD	120.00
	WBS 311		310 x 1060	WS 511/ 515	101.00
	WBS 311 ESD		310 x 1060	WS 511/ 515 ESD	155.00
	BP 90		length 895	WS 511/ 515	44.00
	BP 90 ESD		length 895	WS 511/ 515 ESD	51.00
	WKA		220 x 500	WS 511/ 515	108.00
	WKA ESD		220 x 500	WS 511/ 515 ESD	118.00
	WDA		440 x 300	WS 511/ 515	108.00
	WDA ESD		440 x 300	WS 511/ 515 ESD	118.00
	WJT 3		500 x 370	WS 511/ 515	111.00
	WJT 3 ESD		500 x 370	WS 511/ 515 ESD	132.00
Cable clip set	CC 10		Set = 5 pieces	WS 511/ 515/ ESD	8.90
	WJK 90	profile 840 mm	Made to order using your choice of components listed below. Compact aluminium profile. Will be wired, tested and ready to use.	WS 511/ 515/ ESD	127.00
COMPONENTS:					
Single socket and switch	E2 GB	13 A			17.00
Data connector	E6 GB	RJ 45 shielded for cat. 6 cable, not wired.			24.00
Isolating switch	E9	on-off			POA
Telephone socket	ETEL-2	BT secondary outlet, not wired.			19.00

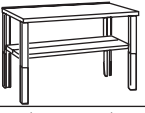
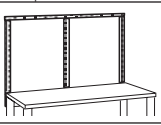
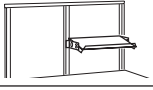
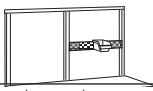
# Heavy duty workbench series HDB/HDBL

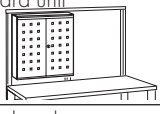
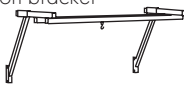

Product	Code	Worktop Material	Worktop D x W mm	Suitable for	Price each £
	HDB 715S	steel	750 x 1500		484.00
	HDB 715P	PVC	750 x 1500		484.00
	HDB 715W	birch plywood	750 x 1500		475.00
	HDB 718S	steel	750 x 1800		554.00
	HDB 718P	PVC	750 x 1800		554.00
	HDB 718W	birch plywood	750 x 1800		525.00
	HDBL 715 S -R*	steel	750 x 1500		439.00
	HDBL 715 P -R*	PVC	750 x 1500		439.00
	HDBL 715 W -R*	birch plywood	750 x 1500		420.00
	HDBL 718 S -R*	steel	750 x 1800		499.00
	HDBL 718 P -R*	PVC	750 x 1800		499.00
	HDBL 718 W -R*	birch plywood	750 x 1800		465.00
	HDBL 715 S -L*	steel	750 x 1500		439.00
	HDBL 715 P -L*	PVC	750 x 1500		439.00
	HDBL 715 W -L*	birch plywood	750 x 1500		420.00
	HDBL 718 S -L*	steel	750 x 1800		499.00
	HDBL 718 P -L*	PVC	750 x 1800		499.00
	HDBL 718 W -L*	birch plywood	750 x 1800		465.00
	ML 06	Dimensions D x W x H 580 x 490 x 762		HDB/HDBL-benches	550.00
Cover plate	MLS	Needed for mounting ML cabinets for HDB/HDBL-benches			14.30
ACCESSORIES:		Dimensions mm		Suitable for	
	HLS 515	500 x 1500		HDB 715	79.00
	HLS 518	500 x 1800		HDB 718	85.00
Height adjustment kit	HAK	(4 pcs)		HDB-workbench	52.00
	HF 150	692 + 692		HDB 715/ HDBL 715	172.00
	HF 180	692 + 992		HDB 718/ HDBL 718	175.00
	HSS 73	310 x 686		HDB 715/718 HDBL 715/718	60.00
	HSS 103	310 x 986		HDB 718/ HDBL 718	64.00
	BP 70	685		HDB 715/718 HDBL 715/718	40.00
	BP 100	985		HDB 718/ HDBL 718	45.00
	HPP 73	686 x 750		HDB 715/718 HDBL 715/718	57.00
	HPP 103	986 x 750		HDB 718/ HDBL 718	67.00
	HCU 73	D x W x H: 310 x 687 x 700 mm		HDB 715/718 HDBL 715/718	290.00
	HSB 150	1500		HDB 715/ HDBL 715	111.00
	HSB 180	1800		HDB 718/ HDBL 718	119.00
Electrical trunking kit	TJK 1504	profile 1358	With 4 switched single sockets. Compact aluminium profile. Wired, tested and ready to use.	HDB/HDBL 715	194.00
	TJK 1804	profile 1658		HDB/HDBL 718	205.00
Electrical trunking	CJK 70	profile 631	Made to order using your choice of components listed below. Compact aluminium profile. Will be wired, tested and ready to use.	HDB 715/718 HDBL 715/718	116.00
	CJK 100	profile 931		HDB/HDBL 718	137.00
COMPONENTS:					
Single socket and switch	E2 GB	13 A			17.00
Data connector	E6 GB	RJ 45 shielded for cat. 6 cable, not wired.			24.00
Isolating switch	E9	on-off			POA
Telephone socket	ETEL-2	BT secondary outlet, not wired.			19.00

\*) Please note: The other leg frame will be replaced with a steel cabinet ML 06 which is ordered separately.

**TRESTON**<sup>®</sup>

Merlin Industrial Products Ltd sales@mipl.org.uk Call 0845 124 9955

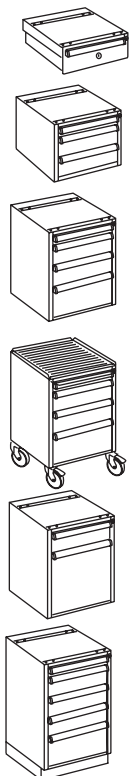
# Steel cabinets series ML/LMC

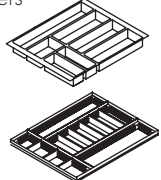

Product	Code	Drawers External height	Dimensions D x W x H	Price each £
Steel cabinets * 	ML 01 ML 01 ESD	140 mm	580 x 453 x 142 mm	145.00 190.00
	ML 02 ML 02 ESD	60 + 2 x 120 mm	580 x 490 x 351 mm	315.00 405.00
	ML 03 ML 03 ESD	60 + 2 x 120 + 180 mm	580 x 490 x 532 mm	400.00 530.00
	ML 04 ML 04 ESD	60 + 2 x 120 + 180 mm Includes top, handle and castors	580 x 490 x 670 mm	490.00 660.00
	ML 05 ML 05 ESD***	120 + 360 mm	580 x 490 x 532 mm	320.00 375.00
	ML 06 ML 06 ESD***	60 + 3 x 120 + 180 mm	580 x 490 x 762 mm	550.00 670.00
Cupboard 	ML 05 D	a cupboard open to left	580 x 490 x 532 mm	370.00
Dividers 	MLX 1	Height 50 mm. Includes 7 fixed compartments. Polystyrene.		23.50
	MLX 1ESD	Height 50 mm. Includes 7 fixed compartments. Conductive polystyrene.		70.00
	MLX 2/50	Height 38 mm. Includes frame, frame, 3 longitudinal dividers and 15 internal dividers. Galvanised steel.		61.00
	MLX 2/100	Height 68 mm. Includes frame, frame, 3 longitudinal dividers and 15 internal dividers. Galvanised steel.		77.00
Cover	MLS	Needed for mounting cabinets to WB/HDB/HDBL		14.30

Product	Code	Drawers External height	Dimensions D x W x H	Price each £
Light steel cabinets ** 	LMC 01 LMC 01 ESD	1 x 100 mm	460 x 370 x 140 mm	142.00 163.00
	LMC 02 LMC 02 ESD	2 x 100 mm	460 x 370 x 245 mm	242.00 259.00
	LMC 04 LMC 04 ESD	4 x 100 mm	460 x 370 x 455 mm	335.00 365.00
	LMC 04 D LMC 04 D ESD	1 x 100 mm + a cupboard height 300 mm open to right	460 x 370 x 455 mm	275.00 290.00
Cover	LMCK 2	Needed for mounting LMC cabinets to WB-benches		22.00

\*) Suitable for benches TP/TPH/WB/SAP/HDB/HDBL – for bench of 700 mm depth and over.

\*\*) Suitable for benches WS/WB/TP/TPH/SAP and trolleys CTR/WTR \*\*\*\*) Made to order only.

# Electrical trunking

Product	Code	Aluminium profile/ construction	Suitable for	Price each £
	TJK 1204	with 4 switched single sockets, 1200 mm long	TP/TPH 712	184.00
	TJK 1504	with 4 switched single sockets, 1500 mm long	TP/TPH 715/915 WB 815 HDBL/HDB 715	194.00
	TJK 1804	with 4 switched single sockets, 1800 mm long	TP/TPH 718/918 WB 818 HDBL/HDB 718	205.00
	WJK 40	length 470 mm	WTR 140	105.00
	WJK 90	length 840 mm	WS 511/515	127.00
	CJK 70	length 631 mm	WB 815/818 HDB/HDBL 715/718	116.00
	CJK 100	length 931 mm	WB 811/818 HDB/HDBL 718	137.00
	TJK 120	length 1058 mm	TPH 712	131.00
	TJK 150	length 1358 mm	TPH 715/915	145.00
	TJK 180	length 1658 mm	TPH 718/918	156.00
	PJK70	length 640 mm	P 0712, P0720	111.00
	PJK100	length 940 mm	P 1012, P1020	128.00
<b>COMPONENTS</b>				
Single socket and switch	E2 GB			17.00
Data connector	E6 GB	RJ 45 shielded for Cat.6 cable, not wired.		24.00
Isolating switch	E9	on-off		POA
Telephone socket	ETEL-2	BT secondary outlet, not wired.		19.00
	CC 8	The clips locate in the 8 mm profile slot	WB/HDB/HDBL	8.90
	CC 10	The clips locate in the 10 mm profile slot	WS/ WTR	8.90
	CC 12	The clips locate in the 12 mm profile slot	TPH	8.90

# Lighting units OL/SL

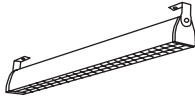
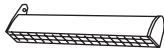
Product	Code	Standard	Suitable for	Price each £
	OL 254/E	<ul style="list-style-type: none"> <li>• 2 fluorescent tube 54 W</li> <li>• an anti-dazzle screen</li> <li>• 3 m cable and connectors</li> <li>• wired and ready to use</li> </ul>	WS /WB/TPH/ HDB/HDBL	265.00
	OL 254 D*	<ul style="list-style-type: none"> <li>• 2 fluorescent tube 54 W</li> <li>• dimmer</li> <li>• 3 m cable and connectors</li> <li>• wired and ready to use</li> </ul>	WS/WB/TPH / HDB/HDBL	345.00
	SL 224 /E	<ul style="list-style-type: none"> <li>• 2 fluorescent tube 24 W</li> <li>• an anti-dazzle screen</li> <li>• 3 m cable and connectors</li> <li>• wired and ready to use</li> </ul>	WS/WB/TPH / HDB/HDBL	193.00
Mounting kit	SL-HKC	Needed for mounting side light to TPH-benches	TPH	14.90

\*) Made to order only





**TRESTON**®

Merlin Industrial Products Ltd sales@mipl.org.uk Call 0845 124 9955

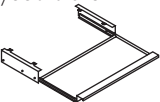

# Panel hooks

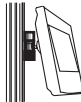
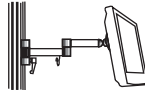
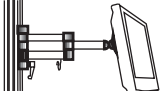
Product	Code	Dimensions D x W mm	Pack pcs	Price/pack £	Product	Code	Dimensions D x W mm	Pack pcs	Price/pack £
Base plate 	K-001		5	7.60	Spring clip 	K-090	Ø 12	5	11.70
	K-010	24	5	9.00		K-091	Ø 18	5	12.40
Universal hook 	K-011	38	5	8.80		K-092	Ø 25	5	12.70
	K-012	100	5	10.80	Tubular cup 	K-101	26 x 75	5	15.20
	K-013	150	5	11.20	Bin rail 	K-110	100	5	19.60
Right-angle hook 	K-020	10	5	11.70	Round cup 	K-120	30 x 82	1	7.20
	K-021	50	5	11.00	Drill shelf 	K-130	42 x 238 x 40	1	11.10
Slanted hook 	K-030	50	5	9.80	Chisel shelf 	K-131	220 x 22 x 32	1	8.20
	K-031	100	5	11.30	Steel shelf 	K-133	120 x 350	1	12.90
Double hook 	K-040	25 x 55	5	11.00	Hose shelf 	K-134	160 x 125	1	20.10
	K-041	25 x 100	5	15.00					
	K-042	25 x 150	5	18.00					
Circle hook 	K-050	Ø 60	5	25.00					
Package hook 	K-060	170	5	19.40					
Pliers hook 	K-070	20 x 43	5	12.40					
Power tool hook 	K-080	Ø 60	5	16.80					
	K-081	Ø 80	5	18.00					

# Keyboard shelf, PC-Stand, LCD holders

Product	Code	Dimensions	Suitable for	Price each £
 <p>Keyboard shelf</p>	NT 500 ESD	Shelf 250 x 500 mm Height 110 mm With pull-out mouse shelf	WB WS TP/ TPH/SAP WTR	135.00
 <p>PC stand</p>	CPU	Vertical adjustment : Width: 130...240 mm Height: 395...500 mm  Horizontal adjustment: Width: 340...460 mm Height: 180...285 mm	WB WS TP/ TPH/SAP WTR/CTR	82.00
 <p>LCD bracket</p>	MH	Hole centres: 75 x 75 or 100 x 100 mm	WB WS WTR TPH**	126.00
 <p>Swivel arm</p>	MA MA 2	<ul style="list-style-type: none"> <li>MA/load 5 kg</li> <li>MA 2/load 10 kg</li> <li>hole centres: 75 x 75 or 100 x 100 mm</li> </ul>	WB WS WTR TPH**	200.00 252.00
 <p>Connector</p>	HKC-MA/MH	Needed for mounting LCD bracket or swivel arm to TPH-benches	TPH	21.00
 <p>Bottle holder</p>	CH	Inside diameter 80 mm. Outside dimensions L x W x H: 110 x 105 x 120 mm	AL2X WS WTR	20.00



## Packing station PPH

Product	Code	Worktop	Frame	Price each £
 <p>Packing bench</p>	PPH 918	900 x 1800 mm	900 x 1500 mm	594.00
	PPH 921	900 x 2100 mm	900 x 1800 mm	640.00
 <p>Equipment bin</p>	PPH TL	Bin size 500 x 186 x 182 mm		25.50
 <p>Cutter</p>	PPL 170	Cutting length: 1500 mm Total length: 1700 mm		293.00

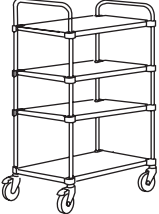
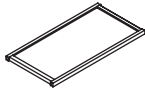
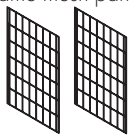
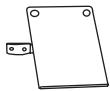

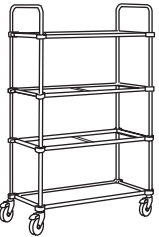

## Adjustable trolleys TRTA

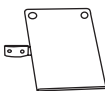
Product	Code	Shelf size D x W	Outer dims D x W x H	Extra shelves (ordered separately)	Price each £
	TRTA 4082	430 x 800 mm	535 x 900 x 1015 mm	TRHA 408	264.00
	TRTA 4102	430 x 1000 mm	535 x 1100 x 1015 mm	TRHA 410	274.00
	TRTA 5082	530 x 800 mm	635 x 900 x 1015 mm	TRHA 508	280.00
	TRTA 5102	530 x 1000 mm	635 x 1100 x 1015 mm	TRHA 510	290.00
	TRTA 4082 ESD	430 x 800 mm	535 x 900 x 1015 mm	TRHA 408 ESD	464.00
	TRTA 4102 ESD	430 x 1000 mm	535 x 1100 x 1015 mm	TRHA 410 ESD	474.00
	TRTA 5082 ESD	530 x 800 mm	635 x 900 x 1015 mm	TRHA 508 ESD	490.00
	TRTA 5102 ESD	530 x 1000 mm	635 x 1100 x 1015 mm	TRHA 510 ESD	525.00
	TRTA 4104	430 x 1000 mm	535 x 1100 x 1535 mm	TRHA 410	440.00
	TRTA 5104	530 x 1000 mm	635 x 1100 x 1015 mm	TRHA 510	470.00
	TRTA 4104 ESD	430 x 1000 mm	535 x 1100 x 1535 mm	TRHA 410	740.00
	TRTA 5104 ESD	530 x 1000 mm	635 x 1100 x 1015 mm	TRHA 510	799.00
				Suitable for trolley	
	TRHA 408	430 x 800 mm		TRTA 4082	68.00
	TRHA 410	430 x 1000 mm		TRTA 4102/ 4104	73.00
	TRHA 508	530 x 800 mm		TRTA 5082	74.00
	TRHA 510	530 x 1000 mm		TRTA 5102/ 5104	82.00
	TRHA 408 ESD	430 x 800 mm		TRTA 4082 ESD	126.00
	TRHA 410 ESD	430 x 1000 mm		TRTA 4102/ 4104 ESD	132.00
	TRHA 508 ESD	530 x 800 mm		TRTA 5082 ESD	133.00
	TRHA 510 ESD	530 x 1000 mm		TRTA 5102/5104 ESD	146.00
	NET 2		364 x 604 mm	(1 pair for 2-shelf trolley) (2 pairs for 4-shelf trolley)	44.90
	DSA4 ESD	Size A4		TRTA/ RRT ESD	51.00



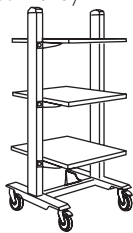

## SMD trolley RRT

Product	Code	Shelf size D x W mm	Outer dimensions D x W x H mm	Suitable for	Price each £
	RRT ESD	530 x 1000	540 x 1100 x 1785  The basic unit consist of 3 supports for reel racks and a perforated steel lower shelf.		630.00
	RR ESD	426 x 960 x 254		RRT ESD	115.00
	DSA4 ESD	Size A4		RRT ESD/ TRTA	51.00



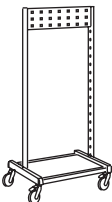
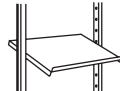

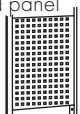
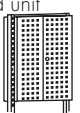

## Universal trolley WTR

Product	Code	Shelf size	Price each £
	WTR 140	650 x 530 mm • standard has 3 shelves • overall height 1415 mm	570.00
	WTR 140 ESD	650 x 530 mm • standard has 3 shelves • overall height 1415 mm	780.00
	TS 605	650 x 530 mm	64.00
	TS 605 ESD	650 x 530 mm	126.00
	TAS 605	650 x 530 mm	120.00
	TAS 605 ESD	650 x 530 mm	179.00
	BP 50	length 525 mm	36.00
	BP 50 ESD	length 525 mm	46.00
	TJK 404	With 4 switched single sockets. Compact aluminium profile. Wired, tested and ready to use. Length 470 mm.	166.00
	WJK 40	Made to order using your choice of components listed below. Compact aluminium profile. Will be wired, tested and ready to use.	95.00
COMPONENTS			
Single socket and switch	E2 GB	13 A	17.00
Data connector	E6 GB	RJ 45 shielded for cat. 6 cable, not wired.	24.00
Isolating switch	E9	on-off	POA
Telephone socket	ETEL-2	BT secondary outlet, not wired.	19.00

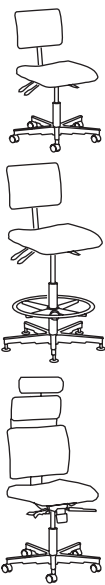
## Industrial trolley IT, heavy duty trolley RV

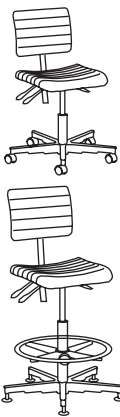



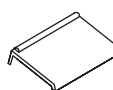



Product	Code	Shelf size	Price each £
	IT 170	D x W x H: 625 x 777 x 1725 mm	346.00
	IT 170 ESD	D x W x H: 625 x 777 x 1725 mm	433.00
	ISS 407	400 x 680 mm	64.00
	ISS 607	600 x 680 mm	71.00
	ISS 407 ESD	400 x 680 mm	68.00
	ISS 607 ESD	600 x 680 mm	75.00
	BP 70	length 685 mm	40.00
	BP 70 ESD	length 685 mm	48.00
	HPP 73	686 x 750 mm	57.00
	HCU 73	310 x 687 x 700 mm	290.00
	RV 608	600 x 767 x 845 mm • worktop of steel • lower shelf of steel • 4 swivel castors Ø 100 mm, 2 with brakes	470.00

# Chairs, foot rests

Product	Code	Seat and back rest	Adjustments	Seat size/ back size mm	Price each £	
	X 30 B X 30 G X 30 R	blue cloth upholstery grey cloth upholstery red cloth upholstery	<ul style="list-style-type: none"> <li>height adjustment by gas lift 425...565 mm</li> <li>tilt of seat is adjustable</li> <li>angle and height of back rest is adjustable</li> <li>with 5 castors</li> </ul>	445 x 455/ 370 x 275	295.00	
	X 30 G ESD	grey cloth ESD-upholstery			295.00	
		X 35 B X 35 G* X 35 R*	blue cloth upholstery grey cloth upholstery red cloth upholstery	<ul style="list-style-type: none"> <li>height adjustment by gas lift 510...770 mm</li> <li>tilt of seat is adjustable</li> <li>angle and height of back rest is adjustable</li> <li>with footrest and floor glides to improve work safety</li> </ul>	445 x 455/ 370 x 275	302.00
		X 35 G ESD*	grey cloth ESD-upholstery			307.00
		X 40 B X 40 G X 40 R	dark blue cloth upholstery grey cloth upholstery red cloth upholstery	<ul style="list-style-type: none"> <li>Height adjustment by gas lift 455...595 mm</li> <li>Angle of seat and back adjustable with one lever</li> <li>Seat depth is adjustable</li> <li>Head rest tilt and height is adjustable</li> <li>with 5 castors</li> </ul>	475 x 455/ 510 x 430 + head rest 100 + height of the head rest 55	605.00
X 40 G ESD		grey cloth ESD-upholstery	605.00			
	X 20 PU X 20 PU ESD	black polyurethane black ESD-polyurethane	<ul style="list-style-type: none"> <li>height adjustment by gas lift 410...560 mm</li> <li>tilt of seat is adjustable</li> <li>angle and height of back rest is adjustable</li> <li>with 5 castors</li> </ul>	370 x 425/ 350 x 265	236.00	
	X 25 PU X 25 PU ESD	black polyurethane black ESD-polyurethane			299.00	
	AR AR ESD	black	<ul style="list-style-type: none"> <li>the armrests have a 80 mm height range and 50 mm depth range</li> <li>they can be set either forwards or backwards</li> <li>by reversing the armrests you can sit closer to the workbench</li> </ul>		73.40 93.50	
	X 10 PU X 10 PU ESD	black polyurethane black ESD-polyurethane	<ul style="list-style-type: none"> <li>height adjustment by gas lift 370...510 mm</li> <li>with 5 castors</li> </ul>	Ø 350 mm	155.00 180.00	
	KJ 200 KJ 200 ESD	blue cloth upholstery grey cloth ESD-upholstery	<ul style="list-style-type: none"> <li>height adjustment by gas lift 540...800 mm</li> <li>saddle seat</li> <li>tilt of seat adjustable</li> <li>with 5 castors</li> </ul>		490.00 560.00	
	JT 2 JT 2 ESD	grey polystyrene black ESD-polystyrene	<ul style="list-style-type: none"> <li>D x W x H:</li> <li>500 x 370 x 100 mm</li> </ul>		37.00 79.00	

\*) Made to order only

# Industrial office screen system



Product	Code	Outer dims W x H	Screen panels	Suitable for	Price each £
	P 0712 FB P 0712 FG P 0712 S	750 x 1245 mm	Blue fabric Grey fabric Perforated panel		302.00 302.00 309.00
	P 0712 FB ESD* P 0712 FG ESD*	750 x 1245 mm	Blue fabric ESD Grey fabric ESD		320.00 320.00
	P 0720 FB P 0720 FG P 0720 S	750 x 2000 mm	Blue fabric Grey fabric Perforated panel		393.00 393.00 385.00
	P 0720 FB ESD* P 0720 FG ESD*	750 x 2000 mm	Blue fabric ESD Grey fabric ESD		420.00 420.00
	P 1012 FB P 1012 FG P 1012 S	1050 x 1245 mm	Blue fabric Grey fabric Perforated panel		309.00 309.00 318.00
	P 1012 FB ESD* P 1012 FG ESD*	1050 x 1245 mm	Blue fabric ESD Grey fabric ESD		330.00 330.00
	P 1020 FB P 1020 FG P 1020 S	1050 x 2000 mm	Blue fabric Grey fabric Perforated panel		401.00 401.00 393.00
	P 1020 FB ESD* P 1020 FG ESD*	1050 x 2000 mm	Blue fabric ESD Grey fabric ESD		436.00 436.00
	T-leg 	TLEG 400	One leg per pack Complete assembly's height: 1275 -1315 mm (low panels) 2030 -2070 mm (high panels)		Suitable for all low panels, and high fabric panels.
T-leg 	TLEG 600	One leg per pack Adjustable feet are provided for fine levelling. Complete assembly's height: 2070 - 2080 mm		Suitable for all high panels, fabric and steel.	59.00
L-leg 	LLEG 250	One leg per pack Complete assembly's height: 1275 -1315 mm (low panels) 2030 -2070 mm (high panels)		Suitable for all low panels, and high fabric panels.	32.00
Corner leg set 	CLEG	One leg per pack Can be used with two panels to create a 90 deg corner.		Suitable for all panels.	41.00
Bin profile 	PBP 70 ESD	Profile 700 mm		P 0712 FB, P 0712 FG, P 0712 S, P 0720 FB, P 0720 FG, P 0720 S	44.00
	PBP 100 ESD	Profile 1000 mm		P 1012 FB, P 1012 FG, P 1012 S, P 1020 FB, P 1020 FG, P 1020 S	48.00
Steel shelf 	PSS 70 ESD	170 x 710 mm Load capacity 10 kg. Max. 3 shelves/one side.		P 0712 FB, P 0712 FG, P 0712 S, P 0720 FB, P 0720 FG, P 0720 S	46.00
	PSS 100 ESD	170 x 1010 mm Load capacity 10 kg. Max. 3 shelves/one side.		P 1012 FB, P 1012 FG, P 1012 S, P 1020 FB, P 1020 FG, P 1020 S	51.00
Cable channel 	PJK 70	640 mm Made to order using your choice of components listed below. Compact aluminium profile.		P 0712 FB, P 0712 FG, P 0712 S, P 0720 FB, P 0720 FG, P 0720 S	111.00
	PJK 100	940 mm Made to order using your choice of components listed below. Compact aluminium profile.		P 1012 FB, P 1012 FG, P 1012 S, P 1020 FB, P 1020 FG, P 1020 S	128.00
Components					
Single socket and switch	E2 GB				17.00
Data connector	E6GB	RJ 45 shielded for cat. 6 cable, not wired.			24.00
Isolating switch	E9	on-off			POA
Telephone socket	ETEL-2	secondary outlet, not wired.			19.00

\*) Made to order only

**TRESTON**<sup>®</sup>

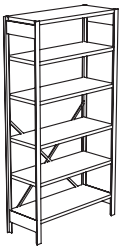
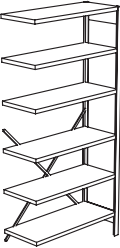

Merlin Industrial Products Ltd sales@mipl.org.uk Call 0845 124 9955

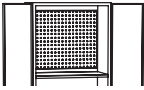
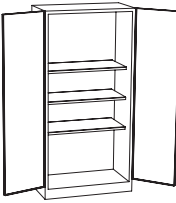
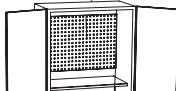
# ESD small parts shelving, shelf cabinets

Product	Code	Dimensions D x W x H	Suitable for	Price each £
	PH 410 ESD	400 x 1000 x 2020 mm		377.00
	PH 510 ESD	500 x 1000 x 2020 mm		420.00
	PH 610 ESD	600 x 1000 x 2020 mm Standard Equipment: 2 front upright, 2 back upright, 2 front uprights, 2 back upright, 6 shelf, 4 side brace, 1 back brace, 4 base plate and 1 set of fittings		458.00
	PH 410L ESD	400 x 1000 x 2020 mm	PH 410 ESD	317.00
	PH 510L ESD	500 x 1000 x 2020 mm	PH 510 ESD	358.00
	PH 610L ESD	600 x 1000 x 2020 mm Standard Equipment: 1 front upright, 1 back upright, 6 shelf, 2 side brace, 1 back brace, 2 base plate and 1 set of fittings	PH 610 ESD	396.00
Shelf	H 410 ESD	400 x 1000 mm	PH 410 ESD/PH 410L ESD	34.00
	H 510 ESD	500 x 1000 mm	PH 510 ESD/PH 510L ESD	40.00
	H 610 ESD	600 x 1000 mm	PH 610 ESD/PH 610L ESD	48.00
Dividing panels, side panels and back: panel made to order only.				
	HK 48 ESD	423 x 800 x 2005 mm Standard fittings: • of semiconductive epoxy powder coated steel • Abloy cabinet lock with two keys, sturdy steel plate set-up double leaf-doors • 4 pcs adjustable legs • 4 shelves, of which one is fixed at the locking device • plinth 100 mm	RLHK 48 H 48 ESD	595.00
	RLHK 48	735 x 600 mm • of semiconductive epoxy powder coated steel	HK 48 ESD	55.00
Extra shelf	H 48 ESD	• 400 x 735 mm – semiconductive	HK 48 ESD	30.00
	HK 180 HK 180 ESD HK 100 ESD*	460 x 915 x 1830 mm 460 x 915 x 1830 mm 460 x 915 x 1015 mm Standard fittings: • HK 180 ESD with 3 shelves • HK 100 ESD with 2 shelves • HK 180/100 ESD of semiconductive epoxy powder coated steel • locking bar system • steel double doors • cabinet base	RLHK 49 H 49K ESD	315.00 420.00 285.00
	RLHK 49	880 x 550 mm • of semiconductive epoxy powder coated steel	HK 180 HK 180 ESD HK 100 ESD	55.00
Extra shelf	H 49K H 49K ESD	450 x 880 mm 450 x 880 mm – semiconductive	HK 180 HK 180/ 100 ESD	26.00 29.00

\*) Made to order only

## Wrist straps, ESD earthing box, ESD bench mat

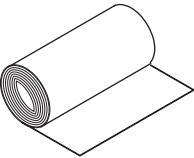
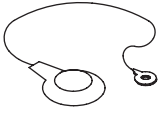
Product	Code	Construction, dimensions etc.	Price each £
Adjustable wrist strap 	JA68Y (R2216)	<ul style="list-style-type: none"> <li>wrist band yellow</li> <li>coiled cord</li> <li>elastic conductive fabric</li> </ul>	20.00
	J3170 (R2206)	<ul style="list-style-type: none"> <li>wrist band</li> <li>coiled cord</li> <li>metal</li> </ul>	34.00
Earthing box 	J6522Y (J6603)	<ul style="list-style-type: none"> <li>1 x 10 mm press stud</li> <li>2 x 4 mm banana socket</li> <li>yellow</li> </ul>	19.00
Bench top ESD-mat 	J063B (PM157)	<ul style="list-style-type: none"> <li>900 x 600 mm</li> </ul>	65.00
Earthing cable 	J4912 (MK 3040)	<ul style="list-style-type: none"> <li>length 0,7 m</li> </ul>	8.00

## Bench stand

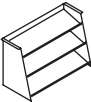
Product	Code	Outer dimensions D x W x H	For bins (ordered separately)	Price each £
Bench stand 	EPL 12 ESD	200 x 455 x 290 mm	12 x stacking bins 1015 or 12 x picking bins 30-1L or 6 x picking bins 30-2L or 6 x picking bins 30-23L	83.00

# Visible storage cabinets

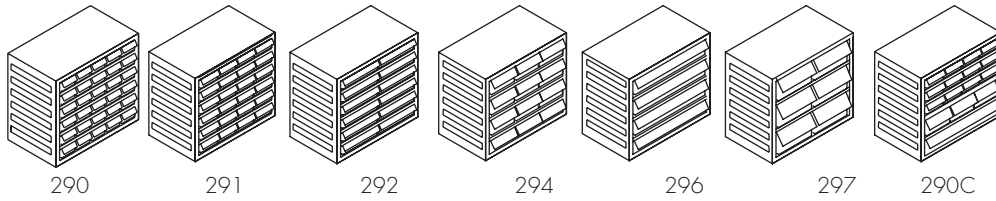

## Series 290

- frame polypropylene
  - shelves galvanised steel
  - drawers polystyrene
  - with labels
- Accessories: dividers, bench top spacemiser

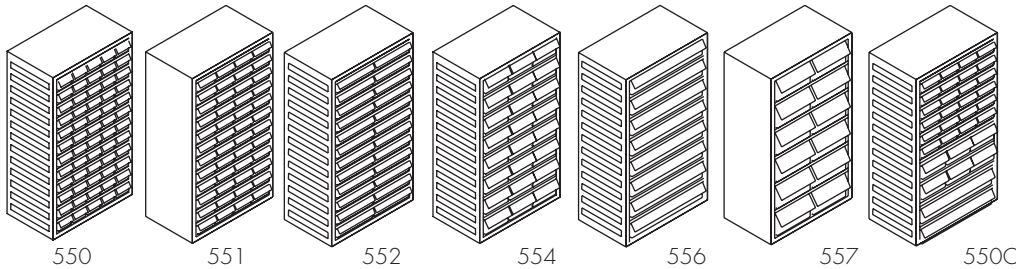



## Series 550

- frame polypropylene
  - shelves galvanised steel
  - drawers polystyrene
  - with labels
- Accessories: dividers, spacemiser, stands, trolley

Cabinets Code	Frame Colour	Drawer			Outer dimensions D x W x H	Pack pcs	Price each* £
		Number	Type	Colour			
290-3	grey	30 pcs	L-00	crystal clear	180 x 310 x 290 mm	1	27.90
291-3	grey	24 pcs	L-01	crystal clear	180 x 310 x 290 mm	1	27.90
292-3	grey	12 pcs	L-02	crystal clear	180 x 310 x 290 mm	1	27.90
294-3	grey	12 pcs	L-04	crystal clear	180 x 310 x 290 mm	1	27.90
296-3	grey	4 pcs	L-06	crystal clear	180 x 310 x 290 mm	1	27.90
297-3	grey	6 pcs	L-07	crystal clear	180 x 310 x 290 mm	1	27.90
290C-3	grey	12 pcs 3 pcs 1 pc	L-01 L-04 L-06	crystal clear	180 x 310 x 290 mm	1	27.90
550-3	grey	60 pcs	L-00	crystal clear	180 x 310 x 550 mm	1	50.00
551-3	grey	48 pcs	L-01	crystal clear	180 x 310 x 550 mm	1	50.00
552-3	grey	24 pcs	L-02	crystal clear	180 x 310 x 550 mm	1	50.00
554-3	grey	24 pcs	L-04	crystal clear	180 x 310 x 550 mm	1	50.00
556-3	grey	8 pcs	L-06	crystal clear	180 x 310 x 550 mm	1	50.00
557-3	grey	12 pcs	L-07	crystal clear	180 x 310 x 550 mm	1	50.00
550C-3	grey	24 pcs 6 pcs 2 pcs	L-01 L-04 L-06	crystal clear	180 x 310 x 550 mm	1	50.00

## Small drawers and dividers

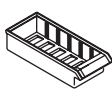
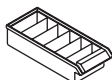
Same drawers used in Series 290/550

Product (Material**)	Code	Outer dims D x W x H	Inner dims D x W x H	Dividers (ordered separately)	Pack pcs	Price each* £
	L-00	175 x 55 x 37 mm	146 x 47 x 32 mm	V-00	120	0.68
	L-01	175 x 69 x 37 mm	146 x 61 x 32 mm	V-01. V-012	96	0.71
	L-02	175 x 138 x 37 mm	146 x 128 x 32 mm	V-02. V-012	48	1.48
	L-04	175 x 92 x 59 mm	146 x 82 x 55 mm	V-04. V-0456	45	1.26
	L-06	175 x 277 x 59 mm	146 x 266 x 55 mm	V-06. V-0456	15	3.15
	L-07	175 x 138 x 81 mm	146 x 128 x 74 mm	V-07. V-078	24	2.10
					Suitable fo drawer	
	V-00			L-00	10	1.70
	V-01			L-01	10	1.80
	V-02			L-02	10	2.32
	V-04			L-04	10	2.42
	V-06			L-06	10	4.62
	V-07			L-07	10	3.80
	V-012			L-01/ L-02	10	3.20
	V-0456			L-04/ L-06	10	3.25
	V-078			L-07	10	4.00

\*) The price includes frame, drawers and labels, without dividers. \*\*) Material: PS = crystal polystyrene

# Spacemiser, cabinet stands and trolley

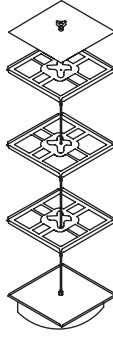
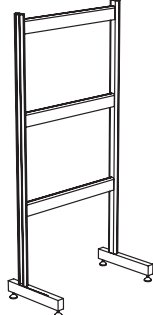
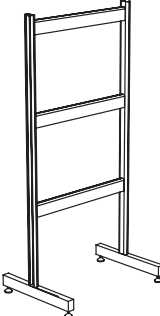
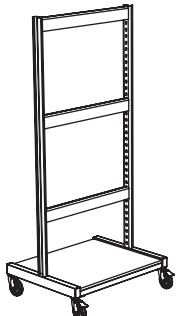
Product	Code	Load capacity	Outer dimensions D x W x H mm	Cabinets (ordered separately)	Pack pcs	Price each £
Bench top spacemiser 	PTP-5	50 kg	310 x 360 x 300/ 310 x 360 x 560	290...290C/ 550...550C (for 2 cabinets)	1	65.00
Spacemiser 	12-550	400 kg	500 x 500 x 1730	550...550C (for 12 cabinets)	1	179.00
	12-550 Kit	400 kg	500 x 500 x 1730	With cabinets 4 x 551-3 4 x 554-3 4 x 557-3	1	779.00
Single stand 	BS-550 L	50 kg	420 x 760 x 1585	550...550C (for 4 cabinets)	1	220.00
Double stand 	BS-550 T	100 kg	600 x 760 x 1585	550...550C (for 8 cabinets)	1	230.00
Trolley 	BT-550	150 kg	600 x 760 x 1700	550...550C (for 8 cabinets)	1	275.00

# Storage cabinets

Series 300

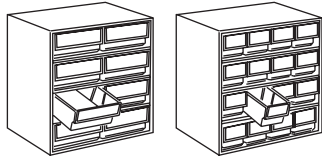

0830

1630

Series 400

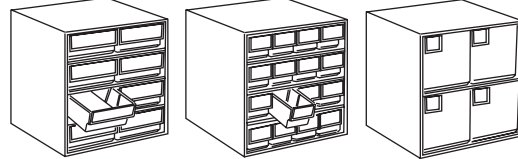

0840

1640

0440

## Storage Cabinets

- frame steel
- shelves galvanised steel
- drawers polystyrene or polypropylene
- with labels and back stops

Accessories:

Dividers, retaining bars, turntables

Cabinet without bins

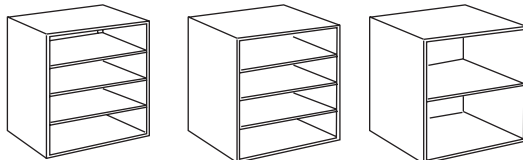

0030

0040

0041

Cabinets	Bins				Frame D x W x H	Pack pcs	Price each* £
	Colour	Material	Number	Type			
0830-1	crystal clear	polystyrene PS	8 pcs	3020	300 x 400 x 395 mm	1	83.00
0830-3	grey	polypropylene PP					83.00
0830-5	red	polypropylene PP					83.00
0830-6	blue	polypropylene PP					83.00
1630-1	crystal clear	polystyrene PS	16 pcs	3010	300 x 400 x 395 mm	1	92.00
1630-3	grey	polypropylene PP					92.00
1630-5	red	polypropylene PP					92.00
1630-6	blue	polypropylene PP					92.00
0840-1	crystal clear	polystyrene PS	8 pcs	4020	400 x 400 x 395 mm	1	92.00
0840-3	grey	polypropylene PP					92.00
0840-5	red	polypropylene PP					92.00
0840-6	blue	polypropylene PP					92.00
1640-1	crystal clear	polystyrene PS	16 pcs	4010	400 x 400 x 395 mm	1	108.00
1640-3	grey	polypropylene PP					108.00
1640-5	red	polypropylene PP					108.00
1640-6	blue	polypropylene PP					108.00
0440-1	crystal clear	polystyrene PS	4 pcs	4040	400 x 400 x 395 mm	1	90.00
0440-5	red	polystyrene HIPS					90.00
0440-6	blue	polystyrene HIPS					90.00
0030	Cabinet without bins				300 x 400 x 395 mm	1	52.00
0040	Cabinet without bins				400 x 400 x 395 mm	1	64.00
0041	Cabinet without bins				400 x 400 x 395 mm	1	56.00

## Dividers

Product	Code	Suitable for	Pack	Price/pack
Cross dividers	D-10	shelf bins 3010...5010	10	3.60
	D-20	shelf bins 3020...6020	10	6.30
	V-40	shelf bins 4040	10	15.00
Labels	1868	shelf bins 3010...5010	10	0.50
	1123	shelf bins 3020...6020	10	0.50
	1792	dividers D-10...D-20	100	3.90
Acrylic shields	S-10	shelf bins 3010...5010	10	3.20
	S-20	shelf bins 3020...6020	10	5.20
Back stop	BS-6 M	shelf bins 3010...6020	10	1.20

\*) The price includes colour bins and labels, without dividers.

# Turntable assemblies, retaining bars and dividers

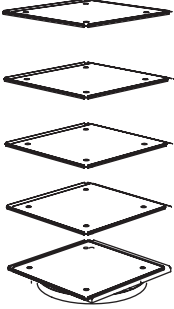
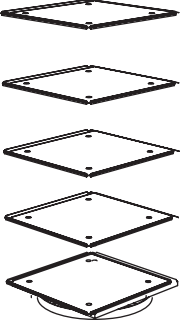
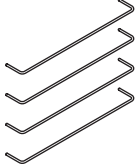
Product	Code	Load capacity	Outer dimensions D x W x H mm	Cabinets (ordered separately)	Pack pcs	Price each £
Turntable assemblies 	16-300	ca.800 kg	700 x 700 x 1680	TRESTON cabinets 0830/1630	1	370.00
Turntable assemblies 	16-400	ca.800 kg	800 x 800 x 1680	TRESTON cabinets 0840/1640/0440	1	405.00
Retaining bars 	A-400	Suitable for TRESTON cabinets 0830/1630/0840/1640/ 0440			4 pcs= 1 Set	10.30

# High density storage cabinets

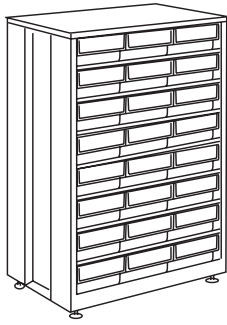

2440

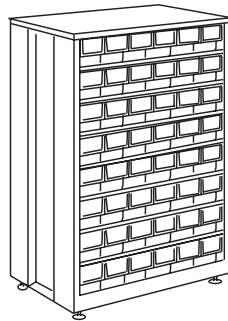

4840

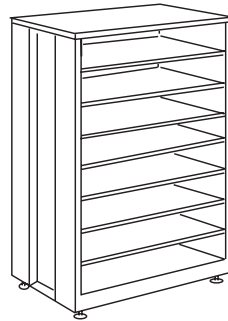

0080

### Storage Cabinets

- frame steel
- shelves galvanised steel
- drawers polypropylene
- with labels and back stops
- adjustable feet
- load capacity 240 kg

Accessories:

Dividers, retaining bars

Cabinets	Bin				Frame D x W x H	Pack pcs	Price each* £
	Colour	Material	Number	Type			
2440-3	grey	polypropylene	24 pcs	4020	410 x 605 x 870 mm	1	340.00
2440-5	red						340.00
2440-6	blue						340.00
4840-3	grey	polypropylene	48 pcs	4010	410 x 605 x 870 mm	1	372.00
4840-5	red						372.00
4840-6	blue						372.00
0080	without bins				410 x 605 x 870 mm	1	225.00

# Castor set, retaining bars

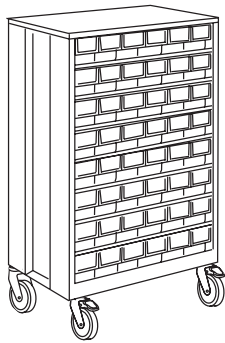

PS-LH

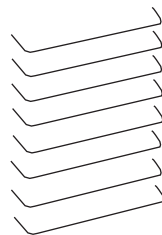

A-605

### Castor set PS-LH

4 castors Ø 100 mm, 2 with brakes. Load capacity of cabinet with castors is 150 kg. Dimensions of cabinet with castors D x W x H: 410 x 605 x 980 mm.

### Retaining bars A-605

Cabinets for mobile service and maintenance vehicles can be equipped with safety/retaining bars. Set includes 8 pieces.

Product	Code		Pack pcs	Price/pack £
Castor set	PS-LH	Castor set = 4 castors Ø 100 mm, 2 with brakes	1 Set	78.00
Dividers	D-10	for shelf bins 3010...5010	10	3.60
	D-20	for shelf bins 3020...6020	10	6.30
Labels	1868	for shelf bins 3010...5010	10	0.50
	1123	for shelf bins 3020...6020	10	0.50
	1792	for dividers D-10...D-20	100	3.90
Acrylic shields	S-10	for shelf bins 3010...5010	10	3.20
	S-20	for shelf bins 3020...6020	10	5.20
Back stop	BS-6 M	for shelf bins 3010...6020	10	1.20
Retaining Bars	A-605	for cabinets 2440, 4840	1 set = 8 pcs	35.00

# Shelf bins

Product *	Code	Colour	Material **	Outer dimensions	Dividers	Pack pcs	Price each bin* £
	3010-1	crystal clear	PS	300 x 92 x 82	D-10	30	3.20
	3010-3	grey	PP				2.90
	3010-5	red	PP				2.90
	3010-6	blue	PP				2.90
	3015-1	crystal clear	PS	300 x 132 x 100	D-15	30	4.10
	3015-3	grey	PP				3.90
	3015-5	red	PP				3.90
	3015-6	blue	PP				3.90
	3020-1	crystal clear	PS	300 x 186 x 82	D-20	15	4.60
	3020-3	grey	PP				4.40
	3020-5	red	PP				4.40
	3020-6	blue	PP				4.40
	4010-1	crystal clear	PS	400 x 92 x 82	D-10	30	3.80
	4010-3	grey	PP				3.50
	4010-5	red	PP				3.50
	4010-6	blue	PP				3.50
	4015-1	crystal clear	PS	400 x 132 x 100	D-15	20	5.10
	4015-3	grey	PP				4.80
	4015-5	red	PP				4.80
	4015-6	blue	PP				4.80
	4020-1	crystal clear	PS	400 x 186 x 82	D-20	15	5.50
	4020-3	grey	PP				5.10
	4020-5	red	PP				5.10
	4020-6	blue	PP				5.10
	5010-1	crystal clear	PS	500 x 92 x 82	D-10	30	4.90
	5010-3	grey	PP				4.40
	5010-5	red	PP				4.40
	5010-6	blue	PP				4.40
	5015-3	grey	PP	500 x 132 x 100	D-15	20	5.70
	5015-5	red	PP				5.70
5015-6	blue	PP	5.70				
5020-1	crystal clear	PS	500 x 186 x 82	D-20	15	6.50	
5020-3	grey	PP				6.10	
5020-5	red	PP				6.10	
5020-6	blue	PP				6.10	
6015-3	grey	PP	600 x 132 x 100	D-15	15	6.70	
6015-5	red	PP				6.70	
6015-6	blue	PP				6.70	
6020-1	crystal clear	PS	600 x 186 x 82	D-20	15	7.20	
6020-3	grey	PP				6.80	
6020-5	red	PP				6.80	
6020-6	blue	PP				6.80	
4040-1***	crystal clear	PS	400 x 186 x 180	V-40	12	13.50	
4040-5***	red	HIPS				13.50	
4040-6***	blue	HIPS				13.50	
							Price/pack
Cross dividers	D-10		PP	for shelf bins	3010...5010	10	3.60
	D-15		PP	for shelf bins	3015...6015	10	4.75
	D-20		PP	for shelf bins	3020...5020	10	6.30
	V-40		PP	for shelf bins	4040	10	15.00
Labels	1868			for shelf bins	3010...5010	10	0.50
	3532			for shelf bins	3015...6015	10	0.50
	1123			for shelf bins	3020...6020	10	0.50
	1792			for dividers	D-10...D-20	100	3.90
Acrylic shields	S-10	crystal clear	PS	for shelf bins	3010...5010	10	3.20
	S-15	crystal clear	PS	for shelf bins	3015...6015	10	4.20
	S-20	crystal clear	PS	for shelf bins	3020...6020	10	5.20
Back stop	BS-6 M	Backstops prevent the bins from falling out of the cabinet whenever components are picked			3010...4020	10	2.10
Blanking piece	FP-6 M	Blanking piece to produce flat surface for labels on inside rear wall of bins.			3010...6020	10	1.80

\*) The price includes shelf bins and labels, without dividers.



\*\*\*) Material: PS = crystal polystyrene, PP = polypropylene,

HIPS = impact resistant, coloured polystyrene (\*\*\*) Made to order only.

# Stacking bins

Product	Code	Colour	Material **	Outer dimensions D x W x H	Dividers	Labels	Pack pcs	Price each bin* £
	1015-1	crystal clear	PS	165 x 105 x 75	-	E-10	60	1.55
	1015-3	grey	PP					1.50
	1015-5	red	PP					1.50
	1015-6	blue	PP					1.50
	1520-1	crystal clear	PS	192 x 149 x 105	-	E-15	45	3.20
	1520-3	grey	PP					2.95
	1520-5	red	PP					2.95
	1520-6	blue	PP					2.95
	1525-1	crystal clear	PS	250 x 149 x 130	V-14	E-15	30	4.65
	1525-3	grey	PP					4.60
	1525-5	red	PP					4.60
	1525-6	blue	PP					4.60
	1930-1	crystal clear	PS	300 x 186 x 156	V-19	E-20	24	7.00
	1930-3	grey	PP					6.30
	1930-5	red	PP					6.30
	1930-6	blue	PP					6.30
	1940-1	crystal clear	PS	400 x 186 x 156	V-19	E-20	24	8.50
	1940-3	grey	PP					8.20
	1940-5	red	PP					8.20
	1940-6	blue	PP					8.20
	1950-1	crystal clear	PS	500 x 186 x 182	V-195	E-20	12	12.80
	1950-3	grey	PP					12.50
	1950-5	red	PP					12.50
	1950-6	blue	PP					12.50
	3040-3	grey	PP	400 x 310 x 156	V-30	E-20	12	11.00
	3040-5	red	PP					11.00
	3040-6	blue	PP					11.00
3050-3	grey	PP	500 x 310 x 182	V-30	E-20	8	14.80	
3050-5	red						14.80	
3050-6	blue						14.80	
Cross dividers	V-14			steel, for stacking bin 1525			1	1.90
	V-19			steel, for stacking bins 1930,1940			1	1.90
	V-195			steel, for stacking bins 1950			1	2.00
	V-30			steel, for stacking bins 3040,3050			1	2.32
Labels + shields	E-10			for stacking bins 1015			10	5.60
	E-15			for stacking bins 1520, 1525			10	6.30
	E-20			for stacking bins 1930, 1940, 1950, 3040, 3050			10	6.80
Bin rail 	700	grey	steel	length 700 mm			1	5.80

# Picking bins

Product	Code	Colour	Material **	Outer dimensions		Pack pcs	Price each bin £
	30-1L-5***	red	HIPS	160 x 99 x 70		60	2.05
	30-1L-6***	blue					2.05
	30-2L-5***	red	HIPS	160 x 198 x 70		30	2.70
	30-2L-6***	blue					2.70
	30-23L-5***	red	HIPS	160 x 198 x 70	2 fixed length dividers	30	3.10
	30-23L-6***	blue					3.10

\*] The price includes stacking bins, without labels and dividers. \*\*] Material: PS = crystal polystyrene, PP = polypropylene, HIPS = impact resistant, coloured polystyrene \*\*\*] Made only to order.

# Stacking bin stands and trolley

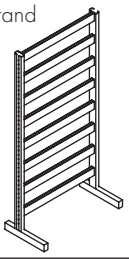
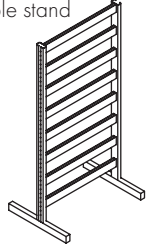
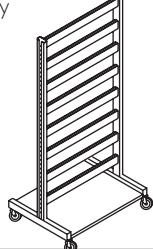
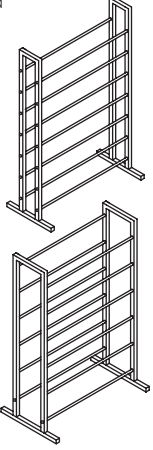
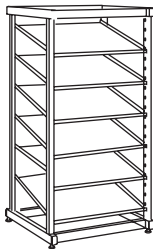
Product	Code	Outer dimensions D x W x H mm	Stacking bins (ordered separately)	Pack pcs	Price each pcs £
Single stand 	BS-160LA	420 x 830 x 1585 mm	With 8 bin rails  One bin rail will hold: 7 pcs stacking bins 1015 or 5 pcs stacking bins 1520 or 5 pcs stacking bins 1525 or 4 pcs stacking bins 1930	1	265.00
Double stand 	BS-160TA	600 x 830 x 1585 mm	With 8 bin rails  One bin rail will hold: 14 pcs stacking bins 1015 or 10 pcs stacking bins 1520 or 10 pcs stacking bins 1525 or 8 pcs stacking bins 1930	1	275.00
Trolley 	BT-170A	600 x 830 x 1700 mm	One bin rail will hold:  14 pcs stacking bins 1015 or 10 pcs stacking bins 1520 or 10 pcs stacking bins 1525 or 8 pcs stacking bins 1930	1	380.00
Stand 	BR-2530	500 x 990 x 1540 mm	With 7 fixed storage levels  One storage level holds 6 pcs stacking bins 1525 or 5 pcs stacking bins 1930	1	305.00
	BR-4050	600 x 990 x 1670 mm	With 6 fixed storage levels  One storage level holds 5 pcs stacking bins 1940 or 5 pcs stacking bins 1950 or 3 pcs stacking bins 3040 or 3 pcs stacking bins 3050	1	315.00
Gravity flow rack 	DBS-808	825 x 830 x 1650 mm	Gravity flow rack holds 48 pcs stacking bins 1940	1	705.00

## Containers

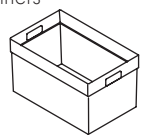
Product	Code	Colour	Material*	Outer dimensions D x W x H mm	Pack pcs	Price each bin £
	10-18L-60	blue	PP	535 x 323 x 150	4	19.00
	10-36L-60	blue	PP	508 x 323 x 280	3	29.00

\* ) Material: PP = polypropylene

**TRESTON**<sup>®</sup>

Merlin Industrial Products Ltd sales@mipl.org.uk Call 0845 124 9955

# KENNOSET shelf bins and stacking bins from recycled plastic

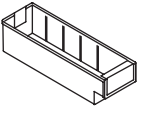
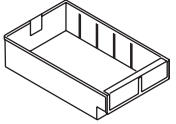
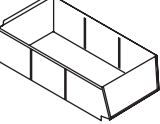
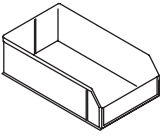
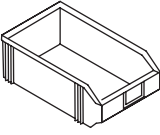
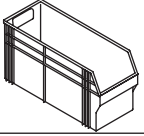
Product	Code	Colour	Material **	Outer dimensions	Dividers / Labels	Pack pcs	Price each bin*£	
    	6310-60 R	blue	PP	300 x 94 x 80 mm	610	40	2.35	
	6410-60 R	blue	PP	400 x 94 x 80 mm	610	40	2.85	
	6510-60 R	blue	PP	500 x 94 x 80 mm	610	40	3.50	
	6320-60 R	blue	PP	300 x 186 x 80 mm	620	20	3.60	
	6420-60 R	blue	PP	400 x 186 x 80 mm	620	20	4.20	
	6520-60 R	blue	PP	500 x 186 x 80 mm	620	20	5.10	
	6316-60 R	blue	PP	300 x 160 x 85 mm	616	20	3.50	
	6416-60 R	blue	PP	400 x 160 x 85 mm	616	20	4.10	
	6516-60 R	blue	PP	500 x 160 x 85 mm	616	20	4.50	
  	6323-60 R	blue	PP	300 x 230 x 120 mm	630	12	5.45	
	6423-60 R	blue	PP	400 x 230 x 150 mm	640	12	7.50	
	6523-60 R	blue	PP	500 x 230 x 150 mm	650	12	8.50	
	6547-60 R	blue	PP	160 x 103 x 73 mm		20	1.50	
	6546-60 R	blue	PP	250 x 146 x 128 mm		20	3.65	
	6545-60 R	blue	PP	340 x 205 x 153 mm		12	6.50	
	6544-60 R	blue	PP	500 x 310 x 180 mm		8	12.50	
		1949-60 R	blue	PP	490 x 185 x 250 mm		12	11.40
3149-60 R		blue	PP	490 x 310 x 250 mm		12	15.20	
		Suitable for bins						Price/pack £
Cross dividers	610	for bins 6310...6510				10	3.90	
	620	for bins 6320...6520				10	5.60	
	616	for bins 6316...6516				10	5.80	
Length dividers	630	for bins 6323-60 R				12	1.15	
	640	for bins 6423-60 R				12	1.60	
	650	for bins 6523-60 R				12	2.00	
Labels	6840	for bins 6310...6510 and 6320...6520				10	0.35	
	6701	for bins 6316...6516				10	0.35	
	6704	for dividers 616				100	3.60	
	1792	for dividers 610/620				100	3.80	
Labels with shields	6700	for bins 6323-60 R ... 6523-60 R				10	0.44	
Labels	6902	for bins 6547-60 R				10	0.44	
	6900	for bins 6546-60 R... 6544-60 R				10	0.44	

\*) The price includes colour bins and labels, without dividers.

\*\*\*) Material: recycled polypropylene PP

# Cabinets (ESD)

Small parts storage cabinets		Storage cabinets		High density storage cabinet	
291 ESD	294 ESD	0830 ESD	1630 ESD	2440 ESD	4840 ESD
551 ESD	554 ESD	0840 ESD	1640 ESD		

Cabinets	Drawers			Frame		Pack pcs	Price each £
	Number	Type	Material	D x W x H	Material		
291-4ESD	24 pcs	L-61-4ESD	HIPS	180 x 310 x 290 mm	PP	1	62.00
294-4ESD	12 pcs	L-64-4ESD				1	62.00
551-4ESD	48 pcs	L-61-4ESD	HIPS	180 x 310 x 550 mm	PP	1	96.00
554-4ESD	24 pcs	L-64-4ESD				1	96.00
0830 ESD	8 pcs	3020-4ESD	PP	300 x 400 x 395 mm	steel	1	123.00
1630 ESD	16 pcs	3010-4ESD				1	140.00
0840 ESD	8 pcs	4020-4ESD	PP	400 x 400 x 395 mm	steel	1	155.00
1640 ESD	16 pcs	4010-4ESD				1	185.00
2440 ESD	24 pcs	4020-4ESD	PP	410 x 605 x 870 mm	steel	1	505.00
4840 ESD	48 pcs	4010-4ESD				1	595.00
PS-LH ESD	Castor set for 2440 ESD and 4840 ESD: 4 castors Ø 100 mm, 2 with brakes					1 Set	108.00

## Turntables and stands for ESD-Cabinets

PTP-5 ESD	12-550 ESD	16-300 ESD/ 16-400 ESD	BS-550L ESD	BS-550T ESD	BT-550 ESD

Product	Code	Outer dimensions D x W x H mm	Cabinets (ordered separately)	Pack pcs	Price each £
Bench top spacemiser	PTP-5 ESD	310 x 360 x 300/ 310 x 360 x 560	2 pcs 291...294 ESD or 551...554 ESD	1	82.00
Spacemiser	12-550 ESD	500 x 500 x 1730	12 pcs 551/554 ESD	1	208.00
Turntable	16-300 ESD	700 x 700 x 1680	16 pcs 0830/1630 ESD	1	392.00
Turntable	16-400 ESD	800 x 800 x 1680	16 pcs 0840/1640 ESD	1	420.00
Single stand	BS-550 L ESD	420 x 760 x 1585	4 pcs 551/554 ESD	1	246.00
Double stand	BS-550 T ESD	600 x 760 x 1585	8 pcs 551/554 ESD	1	260.00
Trolley	BT-550 ESD	600 x 760 x 1700	8 pcs 551/554 ESD	1	355.00

# Shelf bins (ESD)

Product	Code	Colour	Material **	Outer dimensions D x W x H mm	Dividers (ordered separately)	Pack pcs	Price each bin*£
	3010-4ESD	black	PP	300 x 92 x 82	D-10-4ESD	30	4.80
	3020-4ESD	black	PP	300 x 186 x 82	D-20-4ESD	15	6.60
	4010-4ESD	black	PP	400 x 92 x 82	D-10-4ESD	30	5.60
	4015-4ESD	black	PP	400 x 132 x 100	D-15-4ESD	20	7.50
	4020-4ESD	black	PP	400 x 186 x 82	D-20-4ESD	15	7.60
	5010-4ESD	black	PP	500 x 92 x 82	D-10-4ESD	30	7.10
	5015-4ESD	black	PP	500 x 132 x 100	D-15-4ESD	20	9.10
	5020-4ESD	black	PP	500 x 186 x 82	D-20-4ESD	15	9.70
	6015-4ESD	black	PP	600 x 132 x 100	D-15-4ESD	15	10.90
	6020-4ESD	black	PP	600 x 186 x 82	D-20-4ESD	15	11.00
	1562-4ESD	black	PS	625 x 140 x 90	V-15-4ESD (cross) V-60 (length)	20	19.00
	L-61-4ESD	black	HIPS	170 x 69 x 40	V-1-4ESD	96	1.65
	L-64-4ESD	black	HIPS	170 x 92 x 62	V-4-4ESD	45	2.60
							Price/pack
Cross divider	D-10-4ESD	for storage bins 3010...5010-4ESD				10	5.30
	D-15-4ESD	for storage bins 4015...5015-4ESD				10	7.10
	D-20-4ESD	for storage bins 3020...6020-4ESD				10	9.30
	V-15-4ESD	for storage bin 1562-4ESD				10	7.50
Cross divider	V-1-4ESD	for drawer L-61-4ESD				10	2.80
	V-4-4ESD	for drawer L-64-4ESD				10	4.90
Divider, length	V-60	for storage bin 1562-4ESD				1	6.30
Labels	1868	for storage bins 3010 ... 5010-4ESD				10	0.50
	3532	for storage bins 3015 ... 6015-4ESD				10	0.50
	1123	for storage bins 3020 ... 6020-4ESD				10	0.50
	1792	for dividers D-10...D-20				100	3.90
Acrylic shields	S-10	not conductive, for storage bins 3010 ... 5010-4ESD				10	3.20
	S-15	not conductive, for storage bins 3015 ... 6015-4ESD				10	4.20
	S-20	not conductive, for storage bins 3020 ... 6020-4ESD				10	5.20
Back stop	BS-6 ESD	conductive, for storage bins 3010 ... 6020-4ESD				10	2.30

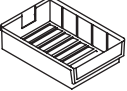
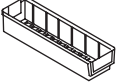
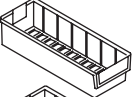
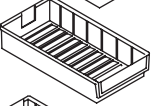
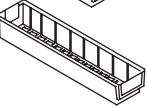
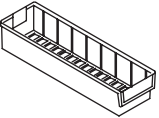
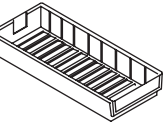
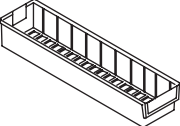
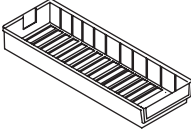
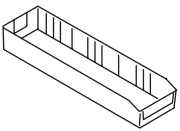
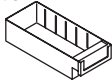
\*) The price includes bins and labels, without dividers.

\*\*) Material: PP = semiconductive polypropylene, PS = semiconductive polystyrene

Merlin Industrial Products Ltd sales@mipl.org.uk Call 0845 124 9955

# Stacking bins, picking bins and storage boxes (ESD)

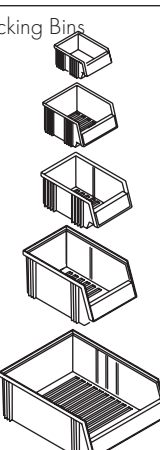
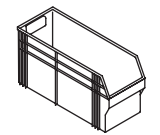
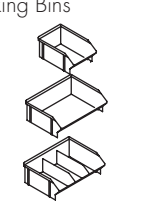
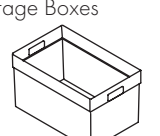
Product	Code	Colour	Material	Outer dimensions D x W x H mm	Dividers	Labels	Pack pcs	Price each bin £	
					(ordered separately)				
	1015-4ESD	black	PP	165 x 105 x 75		E-10	60	2.15	
	1520-4ESD	black	PP	192 x 149 x 105		E-15	45	4.50	
	1525-4ESD	black	PP	250 x 149 x 130	V-14	E-15	30	6.30	
	1930-4ESD	black	PP	300 x 186 x 156	V-19	E-20	24	12.00	
	1940-4ESD	black	PP	400 x 186 x 156	V-19	E-20	24	14.20	
	1950-4ESD*	black	PP	500 x 186 x 182	V-195	E-20	12	29.00	
	3040-4ESD*	black	PP	400 x 310 x 156	V-30	E-20	12	23.00	
	3050-4ESD*	black	PP	500 x 310 x 182	V-30	E-20	8	33.00	
	1949-4ESD*	black	PP	490 x 185 x 250		—	12	25.50	
	3149-4ESD*	black	PP	490 x 310 x 250		—	12	33.00	
Labels + shields (not conductive)	E-10	for stacking bins 1015						10	5.60
	E-15	for stacking bins 1520, 1525						10	6.30
	E-20	for stacking bins 1930, 1940, 1950, 3040, 3050						10	6.80
Dividers (semiconductive steel)	V-14	for stacking bins 1525						1	1.90
	V-19	for stacking bins 1930, 1940						1	1.90
Product	Code	Colour	Material	Outer dimensions D x W x H mm			Pack pcs	Price each bin £	
	30-1L-4ESD	black	HIPS	160 x 99 x 70			60	2.65	
	30-2L-4ESD	black	HIPS	160 x 198 x 70			30	4.00	
	30-23L-4ESD	black	HIPS	160 x 198 x 70	2 fixed length dividers		30	4.50	
	10-18L-4ESD	black	PS	535 x 323 x 150			4	30.00	
	10-36L-4ESD	black	PS	508 x 323 x 280			3	44.00	

## Stacking bins stands (ESD)

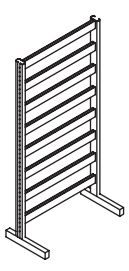
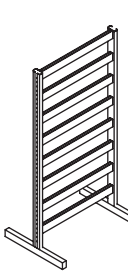
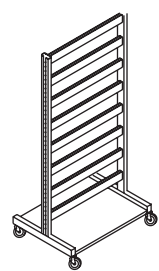
			<b>Single stand</b> Stacking bins (ordered separately) 7 pcs 1015/rail or 5 pcs 1520/rail or 5 pcs 1525/rail or 4 pcs 1930/rail	
			<b>Double stand/ Trolley</b> Stacking bins (ordered separately) 14 pcs 1015/rail or 10 pcs 1520/rail or 10 pcs 1525/rail or 8 pcs 1930/rail	
			BS-160LA ESD	BS-160TA ESD
Product	Code	Outer dimensions D x W x H mm	Load capacity	Price £
Single stand	BS-160 LA ESD	420 x 820 x 1585	120 kg	310.00
Double stand	BS-160 TA ESD	600 x 820 x 1585	240 kg	335.00
Trolley	BT-170 A ESD	600 x 820 x 1700	150 kg	450.00

\*) Made only to order.

**TRESTON**<sup>®</sup>

Merlin Industrial Products Ltd sales@mipl.org.uk Call 0845 124 9955

# GENERAL CONDITIONS OF SALE

## TERMS OF PAYMENT

Nett, payment in full within 30 days of invoice date.

## PRICES

All goods are invoiced at the prices ruling at the time of despatch. All prices are subject to the addition of carriage and packing at cost, and VAT.

## ORDER AND CANCELLATIONS

All verbal orders must be confirmed to us in writing and clearly marked 'confirmation'. No cancellations or changes of orders can be accepted except with our confirmed consent and on terms which will indemnify us against loss.

## DELIVERY

Delivery times quoted by us in good faith are intended as estimates only and shall not be considered a contractual obligation, and we shall not be liable for any loss or damage sustained through inability to meet delivery times so stated. Our obligation in delivery is subject to circumstances outside our control such as, but not limited to, labour disputes, strikes, machine breakdown or any other condition of force majeure.

## CLAIMS

- a) Non-delivery of any consignment within 14 days of the date of our invoice must be given to us in writing.
- b) Inspection of goods immediately upon arrival is advised. Damage or shortages must be notified to us and the carrier within three days, and the carrier's note should be endorsed accordingly.
- c) Goods may not be returned to us for any reason whatsoever without our prior agreement in writing. A handling charge may be levied on all items for which there is an agreed return.

## SPECIFICATIONS

All illustrations, dimensions, weights and capacities are approximate only. Items in our catalogues, though of standard design, are subject to a policy of continuous improvement and the right is reserved to incorporate changes without notice.

## OWNERSHIP

The risk in the goods shall pass to buyer on delivery, but the goods remain the property of Treston Ltd until full payment is received. Until then, we may at any time (and without prejudice to any other rights) recover or resell the goods or any part of them and may enter the purchaser's premises for this purpose. The purchaser may not resell the goods to which we retain title unless he informs his buyer of this Condition of Sale prior to such resale.

Treston reserves the right to amend specifications without prior notification.

## TRESTON packaging

Each TRESTON workbench and trolley comes in an individual carton with all necessary fittings and instructions. Modular elements of workbenches are securely packed with styrox protection. Easy assembly with full instructions included.



# Index

## Workbenches

Adjustable bench series WB/ESD.....	2-3
Tilt adjustable workbench series WB TILT/ESD.....	3
Workbench series TP/TPH/SAP/ESD.....	4-5
Workstation series WS/ESD.....	6
Heavy duty workbench series HDB/HDBL.....	7
Packing station PPH and cutter.....	11

## Drawer cabinets

Steel cabinets ML/ESD.....	8
Light steel cabinet LMC/ESD.....	8

## Electrical trunkings and lighting units

Electrical trunking.....	3, 5, 6, 7, 9, 12, 15
Overlight OL.....	9
Side light SL.....	9

## Computer accessories and other accessories

Keyboard shelf NT.....	11
PC stand CPU.....	11
LCD bracket MH/MA.....	11
Bottle holder CH.....	11

## Perforated panels and panel hooks

Perforated panel.....	3, 5, 7, 12, 16
Louvred panel.....	5
Panel hooks.....	10
Cupboard unit.....	12

## Trolleys

Moveable bench CTR/ESD.....	2
Moveable bench SAP/ESD.....	4
Adjustable trolleys TRTA/ESD.....	12
SMD trolley RRT ESD.....	12
Universal trolley WTR/ESD.....	13
Industrial trolley IT/ESD.....	13
Heavy duty trolley RV.....	13

## Chairs, foot rests

Chairs X/ESD.....	14
Foot rests JT/ESD.....	14

## Screen system

Industrial office screen system P/ESD.....	15
--	----

## Small parts shelving, shelf cabinets

Small parts shelving PH ESD.....	16
Shelf cabinets HK/ESD.....	16

## Wrist straps, ESD earthing box, ESD bench mat,

Adjustable wrist straps.....	17
Earthing box.....	17
Bench top ESD-mat.....	17
Earthing cable.....	17
Bench stand.....	17

## Storage cabinets

Visible storage cabinets.....	18
Storage cabinets.....	20
High density storage cabinets.....	22

## Turntable assemblies

Spacemiser 12-550.....	19
Bench top spacemiser PTP.....	19
Turntable assemblies 16-300/400.....	21

## Stands and trolley

Cabinet stands and trolley.....	19
Bin stands and trolley.....	25

## Bins and containers

Small drawers.....	18
Shelf bins.....	23
Stacking bins.....	24
Picking bins.....	24
Containers.....	25

## KENNOSET bins from recycled plastic

Bins from recycled plastic.....	26
---------------------------------	----

## ESD protective cabinets, turntables and stands

Cabinets (ESD).....	27
Turntables (ESD).....	27
Cabinet stands (ESD).....	27
Bin stands (ESD).....	29

## ESD bins

Shelf bins (ESD).....	28
Stacking bins (ESD).....	29
Picking bins (ESD).....	29