

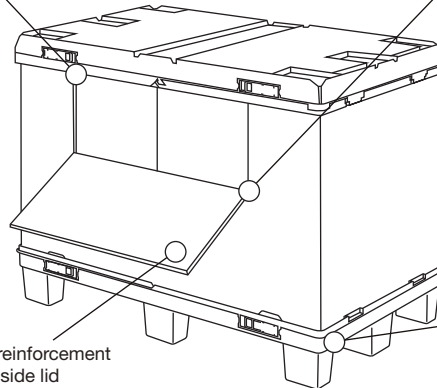

lid location points for interlocking safe pallet stacking

locking latch attaches sleeve to both base and lid



load bearing reinforcement features on inside lid

choice of pallet base

Boxerpac is a versatile system providing outstanding volume for bulk storage and distribution.

### ○ BP120898 / BP120896

The standard Boxerpac comes with nine pallet feet, which locate into the lid feature when stacked. BP121898 version with solid plastic sleeve. BP120896 version with solid cardboard sleeve.

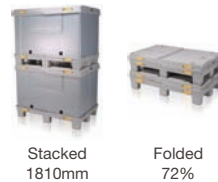

Stacked  
1810mm

Folded  
72%

#### Technical specification

Ext. Top Dim.	1200 x 800 x 910mm
Folded	1200 x 800 x 272mm
Int. Dim.	1140 x 740 x 710mm
Unit Load	500kg/unit
Capacity	600 litres
Weight	28kg
Material	Polypropylene
Colour	Grey



### ○ BP120899 / BP120897

The standard Boxerpac comes with nine pallet feet, which locate into the lid feature when stacked. BP120899 with two drop door plastic sleeve. BP120897 with 2 drop door cardboard sleeve.

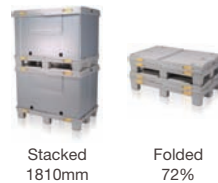

Stacked  
1810mm

Folded  
72%

#### Technical specification

Ext. Top Dim.	1200 x 800 x 910mm
Folded	1200 x 800 x 272mm
Int. Dim.	1140 x 740 x 710mm
Unit Load	500kg/unit
Capacity	600 litres
Weight	28kg
Material	Polypropylene
Colour	Grey



### ○ BP12085H / BP12083H

The standard Boxerpac comes with three runner pallet base, which locate into the lid feature when stacked. BP12085H version with solid plastic sleeve. BP12083H with solid cardboard sleeve.

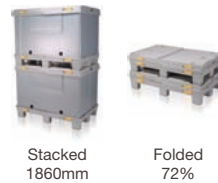

Stacked  
1860mm

Folded  
72%

#### Technical specification

Ext. Top Dim.	1200 x 800 x 930mm
Folded	1200 x 800 x 292mm
Int. Dim.	1140 x 740 x 710mm
Unit Load	500kg/unit
Capacity	600 litres
Weight	28kg
Material	Polypropylene
Colour	Grey



### ○ BP12086H / BP12084H

The standard Boxerpac comes with three runner pallet base, which locate into the lid feature when stacked. BP12086H version with two drop door plastic sleeve. BP12084H version with two drop door cardboard sleeve.



Stacked  
1860mm

Folded  
72%

#### Technical specification

Ext. Top Dim.	1200 x 800 x 930mm
Folded	1200 x 800 x 292mm
Int. Dim.	1140 x 740 x 710mm
Unit Load	500kg/unit
Capacity	600 litres
Weight	28kg
Material	Polypropylene
Colour	Grey



### ○ BP121098 / BP121096

The standard Boxerpac comes with nine pallet feet, which locate into the lid feature when stacked. BP121098 version with solid plastic sleeve. BP121096 version with solid cardboard sleeve.

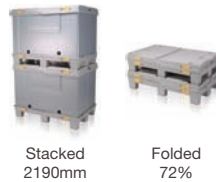

#### Technical specification

Ext. Top Dim.	1200 x 1000 x 1100mm
Folded	1200 x 1000 x 272mm
Int. Dim.	1150 x 945 x 905mm
Unit Load	500kg/unit
Capacity	984 litres
Weight	33kg
Material	Polypropylene
Colour	Black



### ○ BP121099 / BP121097

The standard Boxerpac comes with nine pallet feet, which locate into the lid feature when stacked. BP121099 with two drop door plastic sleeve. BP121097 with two drop door cardboard sleeve.

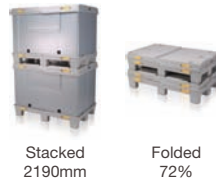

#### Technical specification

Ext. Top Dim.	1200 x 1000 x 1100mm
Folded	1200 x 1000 x 272mm
Int. Dim.	1150 x 945 x 905mm
Unit Load	500kg/unit
Capacity	984 litres
Weight	33kg
Material	Polypropylene
Colour	Black



### ○ BP12105H / BP12103H

The standard Boxerpac comes with three runner pallet base, which locate into the lid feature when stacked. BP12105H version with solid plastic sleeve. BP12103H with solid cardboard sleeve.

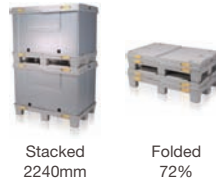

#### Technical specification

Ext. Top Dim.	1200 x 1000 x 1120mm
Folded	1200 x 1000 x 292mm
Int. Dim.	1150 x 945 x 905mm
Unit Load	500kg/unit
Capacity	984 litres
Weight	33kg
Material	Polypropylene
Colour	Black



### ○ BP12106H / BP12104H

The standard Boxerpac comes with three runner pallet base, which locate into the lid feature when stacked. BP12106H version with two drop door plastic sleeve. BP12104H with two drop door cardboard sleeve.

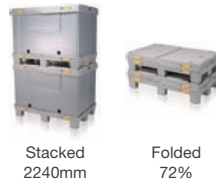

#### Technical specification

Ext. Top Dim.	1200 x 1000 x 1120mm
Folded	1200 x 1000 x 292mm
Int. Dim.	1150 x 945 x 905mm
Unit Load	500kg/unit
Capacity	984 litres
Weight	33kg
Material	Polypropylene
Colour	Black

