

GUEST

The GUEST range of reception counters is ultra-customisable thanks to its variety of modules, finishes and extensive choice of colours and optional complements. It will allow you to create a unique reception space that truly reflects the identity of your company.



- Modular seats, page 12
- Lockers, page 131
- Ergonomic chairs, page 195



Modular & customisable

Counter-top shelf with
«welcome» or «bienvenue»
lettering, or neutral

Melamine worktops 38 mm thick
Melamine cladding 19 mm thick

or metal cladding **new**



White melamine
structure and white
counter base

Full counter-depth legs at the extremities
and space saving intermediary legs
facilitating mobility between modules
(with height-adjustable feet)

POWER AND CABLE MANAGEMENT



Worktops fitted
with 2 cable ports
(except DDA
modules)

2 OPTIONS



LED backlight
(white or colour
changing)



Metal cable
trough for cable
and wire routing

FINISHES & PRODUCT OVERVIEW

2 choices of melamine worktop (+ top 1)

5 choices of melamine cladding (+ top 2)

7 choices of metal cladding finish (+ fin.)**

FROM STOCK

ON REQUEST

ON REQUEST: allow 6 weeks

*Exclusively paired with Amber walnut finish melamine cladding.
 ** Metal cladding: paired exclusively with white worktops.

High standard modules

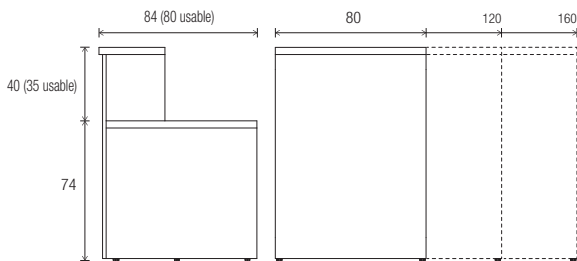

Corner modules

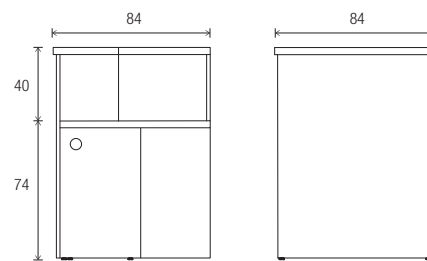

Low DDA module***

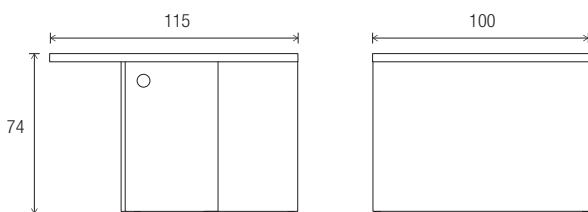

Low offset DDA module***

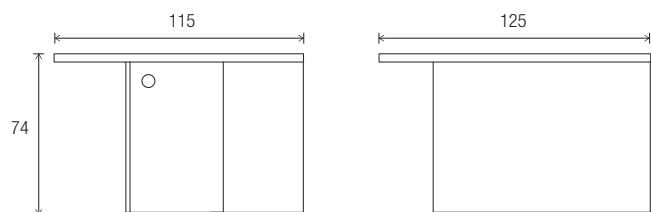



*** DDA: Disability Discrimination Act compliant

PRICES

Price excl. taxes: **From stock** **On request**

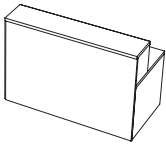
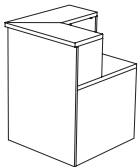
new

HIGH STANDARD MODULES H. 113 CM			Melamine cladding		Metal cladding	
			Ref. + top 2 + top 1	Price excl. tax	Ref. + fin. + MG P	Price excl. tax
	W. 80 cm	Free-standing	6 720 160	£ 624	6 720 133	£ 680
		Intermediary unit	6 720 161	£ 524	6 720 134	£ 580
		Left-hand corner module	6 720 162	£ 573	6 720 135	£ 628
		Right-hand corner module	6 720 163	£ 573	6 720 136	£ 628
	W. 120 cm	Free-standing	6 720 164	£ 708	6 720 137	£ 776
		Intermediary unit	6 720 165	£ 619	6 720 138	£ 687
		Left-hand corner module	6 720 166	£ 660	6 720 139	£ 729
		Right-hand corner module	6 720 167	£ 660	6 720 140	£ 729
	W. 160 cm	Free-standing	6 720 168	£ 813	6 720 141	£ 896
		Intermediary unit	6 720 169	£ 723	6 720 142	£ 807
		Left-hand corner module	6 720 170	£ 765	6 720 143	£ 848
		Right-hand corner module	6 720 171	£ 765	6 720 144	£ 848
	90° left-hand corner module	Intermediary unit	6 720 172	£ 671	6 720 145	£ 813
		Right-hand corner module	6 720 173	£ 681	6 720 146	£ 823
	90° right-hand corner module	Intermediary unit	6 720 174	£ 671	6 720 147	£ 813
		Right-hand corner module	6 720 175	£ 681	6 720 148	£ 823

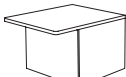
LOW MODULES H. 74 CM			Ref. + top 2 + top 1	Price excl. tax	Ref. + fin. + MG	Price excl. tax
	DDA W. 100 cm	Intermediary unit	6 720 176	£ 514	6 720 156	£ 561
		Left-hand corner module	6 720 177	£ 562	6 720 157	£ 610
		Right-hand corner module	6 720 178	£ 562	6 720 158	£ 610
	DDA W. 125 cm (offset worktop)	Left-hand corner module	6 720 179	£ 572	6 720 149	£ 649
		Right-hand corner module	6 720 180	£ 572	6 720 150	£ 649

OPTIONS			Ref. + fin.	Price excl. tax
Counter-top shelf W. 100 cm	Neutral version		6 720 026	£ 131
	With "Welcome" lettering		6 720 425	£ 204
	With "Bienvenue" lettering		6 720 424	£ 204
	Customised version		For product references and pricing: contact us	
LED backlight kit - Attaches to the lower section of the counter-top shelf or behind the lettering				
	White LED kit		6 720 056	£ 112
	LED kit with light colour changer		6 720 055	£ 213
Cable trough	Cable trough W. 70 cm		6 010 001	£ 33



Descriptions of left and right-hand side are determined in relation to the position of the user.

OVALI

+ Convivial & compact

Toughened glass top 8 mm thick with a satin finish



Melamine covered worktop
28 mm thick

Legs with
height-adjustable feet

2 MODULES



Left-hand module



Right-hand module



Storage unit with
2 shelves, 1 of which
is removable



FINISHES

2 choices of melamine finish (+ top)



NAMZ
Pastel white/Light walnut



NANE
Pastel white/Wenge

FROM STOCK

DIMENSIONS

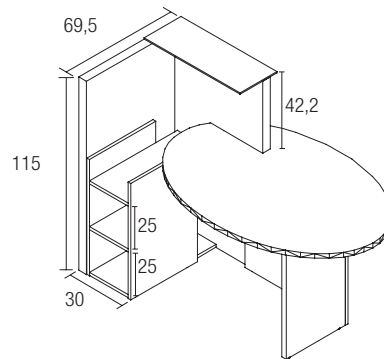
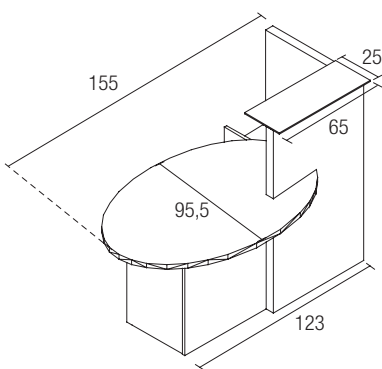

PRICES

Price excl. taxes: **From stock** **On request**

FREE-STANDING MODULES

Left-hand module

6 632 012 + top

Price excl. tax

£ 1 053

Right-hand module

6 632 011 + top

£ 1 053

COME IN

By allowing the combination of different free-standing modules, COME IN reception counters adapt seamlessly to your reception space. The customisable finish for the corner angle module provides an opportunity for an added personal and creative touch.

+ Classic & versatile



FINISHES & PRODUCT OVERVIEW

2

choices of melamine worktop (+ top)

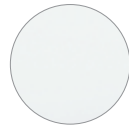

NA
Pastel white



NB
Natural beech

FROM STOCK

3

choices of melamine finish for the corner module modesty panel (+ fin.)

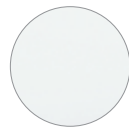

NA
Pastel white



MH
Aluminium grey



RN
Red

FROM STOCK

PRICES

Price excl. taxes: **From stock**

HIGH STANDARD MODULES H. 111 CM

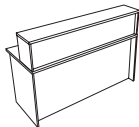

Standard modules

W. 80 cm x D. 70 cm

6 735 051 + top

Price excl. tax

£ 427

W. 120 cm x D. 70 cm

6 735 047 + top

£ 447

W. 160 cm x D. 70 cm

6 735 049 + top

£ 513

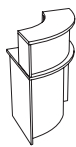

90° corner modules

White

6 735 045 + NA NA

£ 733

Grey

6 735 045 + NA MH or NB MH

£ 666

Red

6 735 045 + NA RN

£ 733

LOW MODULES H. 75.8 CM

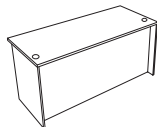

Standard modules

W. 80 cm x D. 70 cm

6 735 052 + top

Price excl. tax

£ 265

W. 120 cm x D. 70 cm

6 735 048 + top

£ 285

W. 160 cm x D. 70 cm

6 735 050 + top

£ 342

W. 120 cm x D. 70 cm DDA*

6 735 044 + top

£ 332

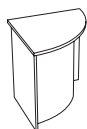

90° corner modules

White

6 735 046 + NA NA

£ 523

Grey

6 735 046 + NA MH or NB MH

£ 475

Red

6 735 046 + NA RN

£ 523

* DDA: Disability Discrimination Act compliant