

QUADRA	CARATTERISTICHE TECNICHE	TECHNICAL FEATURES	CARACTÉRISTIQUES TECHNIQUES	TECHNISCHE EIGENSCHAFTEN
<p><b>Uffici presidenziali placcati in tranciato di vero legno. Fianchi in MDF rivestito in tranciato di vero legno, capitello scrivania in acciaio cromato. Librerie e cassetiere in legno verniciato antracite con mostrine dei cassetti, tops, ante placcate legno naturale. Cassetti scorrevoli su cuscinetti a sfera.</b></p>	<p>Executive ranges in real wood veneer. Mdf sides covered in real wood veneer, desk top support in steel chrome. Wooden bookcases and set of drawers painted in anthracite colour with front drawers, tops, bookcase doors plated in natural wood. Drawers slide on ball bearings.</p>	<p>Bureau président plaqués en bois véritable. Pieds en MDF revetus en bois véritable, capiteau de soutien du plateau de bureau en acier chromé. Armoires et caissons en bois verni couleur anthracite avec façades des tiroirs, tops et portes des armoires plaqué en bois naturel.</p>	<p>Präsidentenbüros mit Echtholz furnier. Seitenteile in mdf mit Echtholz furnier, Schreibtischplattenkapitell in verchromten Stahl. Bücherschränke und Schubladenschränke in lackiertem Holz (Antrazit) mit Ladenfrontteilen, Tops und Schranktüren in Echtholz furnier. Rollschubladenschränke mit Kugellager.</p>	

FINITURE	FINISHES	FINITIONS	BESCHICHTIGUNGEN
<p><b>VERO LEGNO</b>, Wengè Noce (WA), Noce "Satin" (WS).</p>	<p><b>WOOD VENEER</b>, Wengè Walnut (WA), "Satin" walnut (WS).</p>	<p><b>BOIS VERITABLE</b>, Wengè Erable (WA), Noyer Satin (WS).</p>	<p><b>HOLZFURNIERUNG</b>, Wengè Nussbaum (WA), "Satin" Nussbaum (WS).</p>

**Il legno è un materiale naturale e vivo con le caratteristiche che ne derivano. Causa il diverso manifestarsi di fattori naturali come la venatura, la porosità, ecc., non può essere garantita l' identica tonalità delle parti in vero legno. L'esposizione alla luce diretta del sole può causare variazioni di colore. Con il tempo, in oltre, il legno matura e può assumere una tonalità leggermente diversa che non deve essere considerata un difetto.**

**E' quindi di primaria importanza considerare che non sarà possibile ottenere uniformità delle finiture e tonalità nei seguenti casi:**

**Completamenti  
Spedizioni diverse ( in tempi differiti )  
Integrazioni  
Sostituzioni**

The Wood is a live and natural material with its own characteristics. Due to the different natural factors as the veneer, the porosity, etc. etc., the nuances of colours of different parts in wood veneer cannot be guaranteed. The direct exposition to the sun light can cause colours variations during the time. Moreover, the wood matures with the passing of time and it can assume a different colour tone which cannot be considered a defect.

No finishing uniformity can be obtained in the following cases:

Completions  
Multiple shipments (in different times)  
Integrations  
Replacements



Le bois c'est un matériau naturel et vivant avec ses propres caractéristiques. Les variations de nuances, de porosité et de dessin que l'on constate d'un élément à l'autre sont le propre des matériaux naturels, dont ils font le charme. Ces différences peuvent être accentuées selon le sens d'exposition d'une surface à la lumière ( y compris les rayons de la lune), celle-ci affecte la couleur du bois qu'elle peut foncer ou éclaircir selon les ébénisteries.

C'est très important considérer qu'il ne s'agit pas de défauts et qui ne sera pas possible obtenir l'uniformité des nuances et de tonalités dans les cas suivants:

Réassorts  
Livraisons séparées( délais différés)  
Intégrations  
SAV

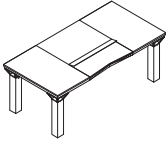
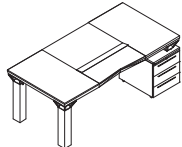
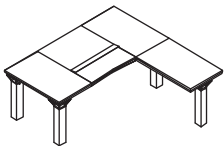
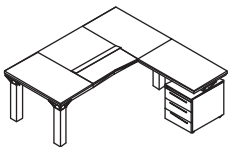

Holz ist ein natürliches und lebendes Material mit seinem eigenen Merkmalen. Wegen natürlicher Umstaenden wie Maserung, Porositaet, usw..., wir koennen die gleiche Toenung der Teilen aus echtem Holz nicht garantieren. Das Holz an die direkte Licht der Sonne zu bringen kann Farbaenderungen verursachen. Waehrend die Zeit vergeht, das Holz wird reif und seine Toenung kann sich leicht aendern, aber das soll nicht als Defekt betrachtet sein. Besonders wichtig zu bemerken ist, dass es nicht moeglich ist, gleichfoermige Beschichtigungen zu bekommen.

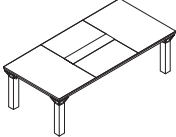

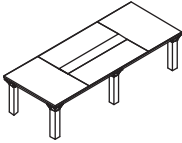
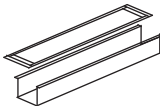
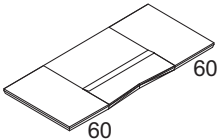
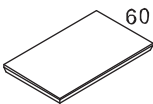
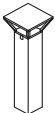
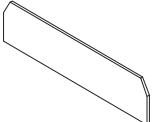
Sortiments  
Mehrfache Lieferungen (teilweise Lieferungen)  
Ergaenzungen  
Ersatz

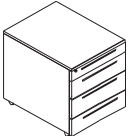
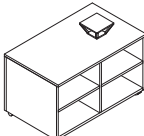
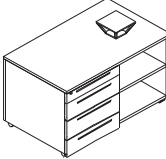
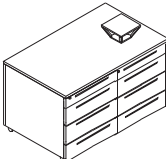
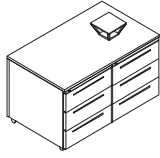
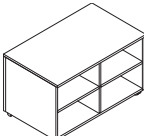
QUADRA	DESCRIZIONE DESCRIPTION DESCRIPTION BESCHREIBUNG	ART. MOD. ART. ART.	L cm.	P cm.	H cm.	EURO		COLLI BOXES COLIS STÜCKE N.	PESO WEIG. POIDS GEW. Kg.	VOL. VOL. VOL. VOL. mc.
						NEUTRO NEUTRAL NEUTRE NEUTRAL	W WA WS			
<b>SCRIVANIE E TAVOLI RIUNIONE</b> DESKS AND CONFERENCE TABLE			<b>BUREAUX ET TABLES DE REUNIONS</b> SCHREIBTISCHE UND SITZUNGSTISCHE							
	<b>scrivania con piedi in legno</b> desk with wooden legs bureau pied en bois Schreibtisch mit Holzfüßen mesa con pies de madera	<b>7421</b> <b>7422</b>	200 220	100 100	73 73		<b>2.977</b> <b>3.107</b>	6 6	92 95	0,63 0,66
	<b>scrivania con cassetiera a 3 cassetti portante e piedi in legno</b> desk with wooden legs and supporting set of drawers bureau pied en bois et caisson porteur 3 tiroirs Schreibtisch mit Holzfüßen und Schubladenschrank Art. 7407 mesa con cajonera 3 cajones y pies de madera	<b>7423</b> <b>7424</b>	200 220	100 100	73 73		<b>3.632</b> <b>3.761</b>	7 7	122,5 125,5	0,77 0,8
	<b>scrivania con allungo piedi in legno</b> desk with extension top, wooden legs bureau avec rallonge, pied en bois Schreibtisch mit Verlängerung und Holzfüßen mesa con extensión pies de madera	<b>7425</b> <b>7426</b>	200 220	200 200	73 73		<b>3.676</b> <b>3.806</b>	8 8	118 118	0,77 0,8
	<b>scrivania con allungo, cass. a 3c.port. e piedi in legno</b> desk with wooden legs, ext.top and supp. set of draw.on castors bureau pied en bois avec rall.et caisson pourt.3 tiroirs Schreibtisch mit Holzfüßen, Verlängerung und Schubladenschrank Art. 7407 mesa con extensión, cajonera con 3 cajones y pies de madera	<b>7427</b> <b>7428</b>	200 220	200 200	73 73		<b>4.331</b> <b>4.459</b>	9 9	148,5 151,5	0,92 0,94
	<b>tavolo circolare con piedini</b> round table on slides table ronde sur patins runder Sitzungstisch auf Kufen mesa circular con pies	<b>7804</b>	130	130	72		<b>882</b>	2	37	0,2
	<b>tavolo riunione, piedi in legno</b> conference table with wooden legs table réunion avec pieds en bois Sitzungstisch mit Holzfüßen mesa de reunión, pies de madera	<b>7429</b>	250	120	73		<b>3.755</b>	6	111,5	0,86

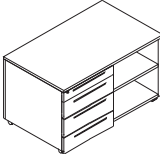
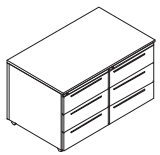
QUADRA	DESCRIZIONE DESCRIPTION DESCRIPTION BESCHREIBUNG	ART. MOD. ART. ART.	L cm.	P cm.	H cm.	EURO		COLLI BOXES COLIS STÜCKE N.	PESO WEIG. POIDS GEW. Kg.	VOL. VOL. VOL. VOL. mc.
						NEUTRO NEUTRAL NEUTRE NEUTRAL	W WA WS			
<b>SCRIVANIE E TAVOLI RIUNIONE</b> DESKS AND CONFERENCE TABLE			<b>BUREAUX ET TABLES DE REUNIONS</b> SCHREIBTISCHE UND SITZUNGTSISCHE							
	<b>tavolo riunione, piedi in legno</b> conference table with wooden legs table réunion avec pieds en bois Sitzungstisch mit Holzfüßen mesa de reunión, pies de madera	<b>7430</b> <b>7431</b>	300 350	120 120	73 73		<b>4.578</b> <b>4.912</b>	8 9	122 162	0,81 0,99
	<b>opzione canalizzazione tavolo riunioni</b> option for channelling the central part of the conference table option pour electification partie centrale table reunions Option: Kabelkanal in der Mitte des Konferenztisches opción canalización mesa de reunión	<b>72</b>	-	-	-	<b>189</b>				
	<b>piano scrivania</b> top for desk plateau bureau Schreibtischplatte encimera de mesa	<b>7400</b> <b>7401</b>	200 220	100 100	6 6		<b>2.002</b> <b>2.132</b>	2 2	64 67	0,36 0,38
	<b>allungo per piano scrivania, solo art. 7400-7401</b> extension top for desk, item 7400-7401 only rallonge pour bureau, seulement pour art. 7400-7401 réunion Verlängerung für Schreibtisch Art. 7400 - 7401 extensión para mesa, sólo art. 7400-7401	<b>7402</b>	100	60	6		<b>455</b>	1	19	0,07
	<b>piede in legno per scrivania o tavolo riunione</b> wooden leg for desk or conference table ped en bois pour bureau ou table de réunion Holzfuss für Schreib- oder Sitzungstisch pie de madera para mesa o mesa de reunión	<b>7403</b>	10	10	67		<b>244</b>	1	7	0,07
	<b>frontale per scrivania vero legno cm.200</b> front panel for desk in real wood cm.200 voile de fond pour bureau en bois 200 cm. Frontpanel für Schreibtisch frontal para mesa verdadera madera 200 cm.	<b>7405</b>	158	2	31		<b>201</b>	1	9,5	0,04
	<b>frontale per scrivania vero legno cm.220</b> front panel for desk in real wood cm.220 voile de fond pour bureau en bois 250 cm. Frontpanel für Schreibtisch frontal para mesa verdadera madera 220 cm.	<b>7406</b>	178	2	31		<b>221</b>	1	10,5	0,04

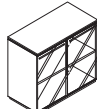
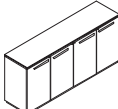
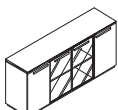
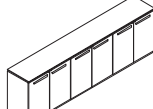
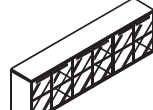
QUADRA	DESCRIZIONE DESCRIPTION DESCRIPTION BESCHREIBUNG	ART. MOD. ART. ART.	L cm.	P cm.	H cm.	EURO		COLLI BOXES COLIS STÜCKE N.	PESO WEIG. POIDS GEW. Kg.	VOL. VOL. VOL. VOL. mc.
						NEUTRO NEUTRAL NEUTRE NEUTRAL	W WA WS			
<b>SCRIVANIE E TAVOLI RIUNIONE</b>						<b>BUREAUX ET TABLES DE REUNIONS</b>				
<b>DESKS AND CONFERENCE TABLE</b>						<b>SCHREIBTISCHE UND SITZUNGSTISCHE</b>				
	<b>cassettiera 3 cassetti portante con capitello</b> set of 3 drawers with capital caisson 3 tiroirs avec chapiteau Schubladenschrank mit 1 Schreibwaren- und 3 Schubladen (als Fusersatz) cajonera 3 cajones con capitel	<b>7407G</b>	47	66	69		<b>949</b>	2	39	0,3
	<b>classificatore portante con capitello</b> set with 1 filing drawer, with capital caisson PDS avec chapiteau Registraturschrank mit 1 Schreibwaren-, 1 Schublade und 1 Hängeregister-Auszug (als Fusersatz) archivador con capitel	<b>7408G</b>	47	66	69		<b>986</b>	2	40	0,3
	<b>cassettiera 3 cassetti su ruote</b> set of 3 drawers on castors caisson 3 tiroirs sur roulettes Schubladenschrank auf Rollen mit 1 Schreibwaren- und 3 Schubladen cajonera 3 cajones sobre ruedas	<b>7409G</b>	47	66	63		<b>872</b>	1	38	0,25
	<b>classificatore su ruote</b> set with 1 filing drawer, on castors caisson PDS sur roulettes Registraturschrank auf Rollen mit 1 Schreibwaren-, 1 Schublade und 1 Hängeregister-Auszug archivador sobre ruedas	<b>7410G</b>	47	66	63		<b>911</b>	1	38	0,25
	<b>mobile di servizio a giorno portante con capitello</b> cabinet with capital meuble service ouvert avec chapiteau Beistelltisch auf Rollen mit offenen Fächern (als Fusersatz) mueble de servicio abierto con capitel	<b>7411G</b>	95	58	69		<b>797</b>	4	57	0,3
	<b>mobile di servizio con cassetti, portante con capitello</b> cabinet with drawers, with capital meuble de service avec tiroirs avec chapiteau Beistelltisch auf Rollen mit 1 Schreibwaren- und 3 Schubladen und offenen Fächern (als Fusersatz) mueble de servicio con cajones, con capitel	<b>7412G</b>	95	58	69		<b>1.338</b>	4	81	0,55
	<b>mobile di servizio con classificatore, portante con capitello</b> cabinet with filing drawers, with capital meuble de service avec P D S avec chapiteau Beistelltisch auf Rollen mit 1 Schreibwaren-, 1 Schublade und 1 Hängeregister-Auszug und offenen Fächern (als Fusersatz) mueble de servicio con archivador con capitel	<b>7413G</b>	95	58	69		<b>1.376</b>	4	81	0,55
	<b>mobile di servizio con cassetti, portante con capitello</b> cabinet with drawers, with capital meuble de service avec tiroirs avec chapiteau Beistelltisch auf Rollen mit 2 x 1 Schreibwaren- und 3 Schubladen und offenen Fächern (als Fusersatz) mueble de servicio con cajones, con capitel	<b>7414G</b>	95	58	69		<b>1.879</b>	4	105	0,8
	<b>mobile di servizio con classificatore, portante con capitello</b> cabinet with filing drawers, with capital meuble de service avec P D S avec chapiteau Beistelltisch auf Rollen mit 2 x 1 Schreibwaren-, 1 Schublade und 1 Hängeregister-Auszug und offenen Fächern (als Fusersatz) mueble de servicio con archivador con capitel	<b>7415G</b>	95	58	69		<b>1.954</b>	4	105	0,8
	<b>mobile di servizio a giorno su ruote</b> cabinet on castors meuble service ouvert sur roulettes Beistelltisch auf Rollen mit offenen Fächern mueble de servicio abierto sobre ruedas	<b>7416G</b>	95	58	63		<b>721</b>	3	56	0,25

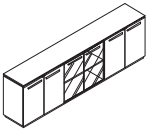
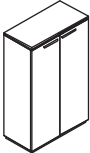
QUADRA	DESCRIZIONE DESCRIPTION DESCRIPTION BESCHREIBUNG	ART. MOD. ART. ART.	L cm.	P cm.	H cm.	EURO		COLLI BOXES COLIS STÜCKE N.	PESO WEIG. POIDS GEW. Kg.	VOL. VOL. VOL. VOL. mc.
						NEUTRO NEUTRAL NEUTRE NEUTRAL	W WA WS			
<b>SCRIVANIE E TAVOLI RIUNIONE</b> DESKS AND CONFERENCE TABLE			<b>BUREAUX ET TABLES DE REUNIONS</b> SCHREIBTISCHE UND SITZUNGSTISCHE							
	<b>mobile di servizio con cassetti, su ruote</b> cabinet with drawers, on castors meuble de service avec tiroirs sur roulettes Beistelltisch auf Rollen mit 1 Schreibwaren- und 3 Schubladen und offenen Fächern mueble de servicio con cajones, sobre ruedas	<b>7417G</b>	95	58	63		<b>1.263</b>	3	80	0,5
	<b>mobile di servizio con classificatore, su ruote</b> cabinet with filing drawers, on castors meuble de service avec P D S sur roulettes Beistelltisch auf Rollen mit 1 Schreibwaren-, 1 Schublade und 1 Hängeregister-Auszug und offenen Fächern mueble de servicio con archivador sobre ruedas	<b>7418G</b>	95	58	63		<b>1.301</b>	3	80	0,5
	<b>mobile di servizio con cassetti, su ruote</b> cabinet with drawers, on castors meuble de service avec tiroirs sur roulettes Beistelltisch auf Rollen mit 2 x 1 Schreibwaren- und 3 Schubladen und offenen Fächern mueble de servicio con cajones, sobre ruedas	<b>7419G</b>	95	58	63		<b>1.803</b>	3	104	0,75
	<b>mobile di servizio con classificatore, su ruote</b> cabinet with filing drawers, on castors meuble de service avec P D S sur roulettes Beistelltisch auf Rollen mit 2 x 1 Schreibwaren-, 1 Schublade und 1 Hängeregister-Auszug und offenen Fächern	<b>7420G</b>	95	58	63		<b>1.874</b>	3	104	0,75
<b>LIBRERIE</b> BOOKCASES			<b>ARMOIRES</b> BÜCHERSCHRANKE							
	<b>libreria 2 porte in legno</b> bookcase 2 wooden doors armoire 2 portes sup., en bois Bücherschrank mit Doppeltüre armario 2 puertas de madera	<b>7432</b>	102	52	84		<b>1.256</b>	5	80,5	0,45
	<b>libreria 2 porte in cristallo</b> bookcase 2 glass doors armoire 2 portes sup., vitrées Bücherschrank mit Doppeltüre aus Glas armario 2 puertas de cristal	<b>7433</b>	102	52	84		<b>1.256</b>	5	86	0,45
	<b>libreria 4 porte in legno</b> bookcase 4 wooden doors armoire 4 portes sup., en bois Bücherschrank mit 2 Doppeltüren armario 4 puertas de madera	<b>7434</b>	201	52	84		<b>2.149</b>	8	158	0,82
	<b>libreria 2 porte laterali legno e 2 centrali cristallo</b> bookcase 2 side wooden and 2 central glass doors armoire 2 portes sup., latérales en bois et 2 centrales vitrées Bücherschrank mit zentraler Doppeltüre aus Glas und 2 Einzeltüren armario 2 puertas laterales y 2 centrales de cristal	<b>7435</b>	201	52	84		<b>2.149</b>	8	166	0,82
	<b>libreria 6 porte in legno</b> bookcase 6 wooden doors armoire 6 portes sup., en bois Bücherschrank mit 3 Doppeltüren armario 6 puertas de madera	<b>7436</b>	300	52	84		<b>2.805</b>	10	211	1,18
	<b>libreria 6 porte cristallo</b> bookcase 6 glass doors armoire 6 portes sup., vitrées Bücherschrank mit 3 Doppeltüren aus Glas armario 6 puertas de cristal	<b>7437</b>	300	52	84		<b>2.805</b>	10	230	1,17

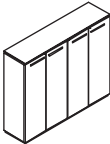
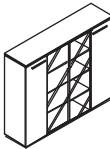
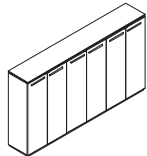
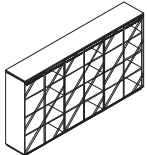
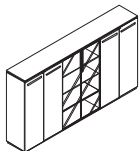
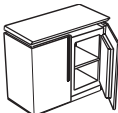
QUADRA	DESCRIZIONE DESCRIPTION DESCRIPTION BESCHREIBUNG	ART. MOD. ART. ART.	L cm.	P cm.	H cm.	EURO		COLLI BOXES COLIS STÜCKE N.	PESO WEIG. POIDS GEW. Kg.	VOL. VOL. VOL. VOL. mc.
						NEUTRO NEUTRAL NEUTRE NEUTRAL	W WA WS			
LIBRERIE BOOKCASES			ARMOIRES BÜCHERSCHRANKE							
	<b>libreria 4 porte laterali legno e 2 centrali cristallo</b> bookcase 4 side wooden and 2 central glass doors armoire 4 portes sup., latérales en bois et 2 centrales vitrées Bücherschrank mit zentraler Doppeltüre aus Glas und 2 Doppeltüren armario 4 puertas laterales de madera y 2 centrales de cristal	<b>7438</b>	300	52	84		<b>2.805</b>	10	219	1,18
	<b>libreria 2 porte in legno</b> bookcase 2 wooden doors armoire 2 portes sup., en bois Bücherschrank mit Doppeltüre armario 2 puertas de madera	<b>7439</b>	102	52	161		<b>1.820</b>	5	132,5	0,64
	<b>libreria 2 porte in cristallo</b> bookcase 2 glass doors armoire 2 portes sup., vitrées Bücherschrank mit Doppeltüre aus Glas armario 2 puertas de cristal	<b>7440</b>	102	52	161		<b>1.820</b>	5	143	0,64
	<b>libreria 4 porte legno</b> bookcase 4 wooden doors armoire 4 portes sup., en bois Bücherschrank mit 2 Doppeltüren armario 4 puertas de madera	<b>7441</b>	201	52	161		<b>2.963</b>	8	245,5	1,18
	<b>libreria 2 porte laterali legno e 2 centrali cristallo</b> bookcase 2 side wooden and 2 central glass doors armoire 2 portes latérales en bois et 2 centrales vitrées Bücherschrank mit zentraler Doppeltüre aus Glas und 2 Einzeltüren armario 2 puertas laterales de madera y 2 centrales de cristal	<b>7442</b>	201	52	161		<b>2.963</b>	8	258	1,18
	<b>libreria 6 porte legno</b> clothes-hanger for high bookcase porte-manteau pour armoire haute Bücherschrank mit 3 Doppeltüren armario 6 puertas de madera	<b>7443</b>	300	52	161		<b>3.833</b>	10	340,5	1,66
	<b>libreria 6 porte cristallo</b> bookcase 6 glass doors armoire 6 portes sup., vitrées Bücherschrank mit 3 Doppeltüren aus Glas armario 6 puertas de cristal	<b>7444</b>	300	52	161		<b>3.833</b>	10	374	1,66
	<b>libreria 4 porte laterali legno e 2 centrali cristallo</b> bookcase 4 side wooden and 2 central glass doors armoire 4 portes latérales en bois et 2 centrales vitrées Bücherschrank mit zentraler Doppeltüre aus Glas und 2 Doppeltüren armario 4 puertas laterales de madera y 2 centrales de cristal	<b>7445</b>	300	52	161		<b>3.833</b>	10	353	1,66
	<b>kit frigo Lt.50 -220 V. per vano da cm. 50</b> refrigerator 50 Lt.-220 V. for element cm.50 kit frigo 50 Lt.-220 V. pour compartiment de 50 cm. Einbau-Kit Kühlschranks (50 Lt.-220 V) für 50 cm Element kit refrigerador Lt. 50-220 V. para vano de 50 cm.	<b>7547</b>	-	-	-		<b>979</b>	1	22	0,18
	<b>kit frigo Lt.50 -220 V. per vano da cm. 100 laterale</b> refrigerator 50 Lt.-220 V. for element cm.100 kit frigo 50 Lt.-220 V. pour compartiment de 100 cm. Einbau-Kit Kühlschranks (50 Lt.-220 V) für 100 cm Element kit refrigerador Lt. 50-220 V. para vano de 100 cm.	<b>7548</b>	-	-	-		<b>1.003</b>	1	25,5	0,19

specificare in quale articolo deve essere inserito; salvo diversa richiesta il kit frigo avrà la porta incernierata a destra - state in which model it must be installed; except otherwise requested, the refrigerator door will be hinged on the right side - spécifier l' article qu' on doit équiper; sauf instructions le kit frigo aura la porte avec charnières à droite - bitte angeben, wo er hineingestellt werden soll; wenn keine andere anfrage, die tür des eisschranksatzes öffnet sich nach rechts - especificar en cual modelo tiene que ser metido;salvo diferentes instrucciones, el kit refrigerado tendrá la puerta con bisagra a la derecha

QUADRA	DESCRIZIONE DESCRIPTION DESCRIPTION BESCHREIBUNG	ART. MOD. ART. ART.	L cm.	P cm.	H cm.	EURO		COLLI BOXES COLIS STÜCKE N.	PESO WEIG. POIDS GEW. Kg.	VOL. VOL. VOL. VOL. mc.
						NEUTRO NEUTRAL NEUTRE NEUTRAL	W WA WS			

LIBRERIE BOOKCASES	ARMOIRES BÜCHERSCHRANKE
-----------------------	----------------------------

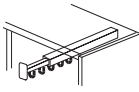
	<b>portabiti per libreria alta</b> clothes-hanger for high bookcase penderie pour armoire haute Einbau-Kit Bügelsatz für hohen Bücherschrank colgadero para armario alto	<b>0661</b>	-	-	-	<b>48</b>		1	0,5	0,01
--	--	-------------	---	---	---	-----------	--	---	-----	------

BOISERIE BOISERIE	BOISERIE BOISERIE
----------------------	----------------------

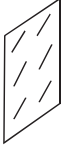
	<b>boiserie con reggimensole ed attacco a muro</b> boiserie with fixing boiserie avec fixation Boiserie mit Befestigung boiserie con sustentación para estantes y enganche de pared	<b>7448</b>	130	2	164		<b>488</b>	1	35	0,29
--	---	-------------	-----	---	-----	--	------------	---	----	------

	<b>mensola in legno per boiserie</b> shelf for boiserie consol en bois pour boiserie Regal für Boiserie estante de madera para boiserie	<b>7449</b>	130	30	2		<b>184</b>	1	6	0,01
--	---	-------------	-----	----	---	--	------------	---	---	------

	<b>mensola in vetro temperato satinato per boiserie</b> glass shelf for boiserie consol vitrée pour boiserie Glas-Regal für Boiserie estante de vidrio templado satinado para boiserie	<b>7450</b>	130	30	1		<b>239</b>	1	10	0,01
--	--	-------------	-----	----	---	--	------------	---	----	------

	<b>tavolino salotto</b> drawing-room table table basse pour salon Salon-Tischchen mesa baja para sala	<b>9028G</b>	64	64	40		<b>385</b>	1	18	0,09
--	---	--------------	----	----	----	--	------------	---	----	------

--	--	--	--	--	--	--	--	--	--	--

--	--	--	--	--	--	--	--	--	--	--

--	--	--	--	--	--	--	--	--	--	--

--	--	--	--	--	--	--	--	--	--	--