

PREMIER 1 WORKBENCH RANGE

A flat pack modular workbench system with a weight capacity of 400kg UDL. All workbenches are 840mm high as standard, other heights available. All Premier workbench frames, cabinet and drawer carcasses are epoxy polyester powder coated in Mid Grey RAL 7001. All premier cabinet doors and drawers are epoxy polyester powder coated in Premier Blue.

WORKTOPS

- A = 25mm thick hardwood veneer top.
- B = 27mm thick industrial marble grey lino.
- C = 25mm thick plain cut MDF.

WORKBENCHES

L x W(mm)	Top	Code	£
1500 x 600	Veneer	PW156A	267.28
1500 x 700	Veneer	PW157A	311.21
1500 x 600	Lino	PW156B	309.17
1500 x 700	Lino	PW157B	341.92
1500 x 600	MDF	PW156C	216.52
1500 x 700	MDF	PW157C	258.46
2000 x 600	Veneer	PW126A	275.32
2000 x 700	Veneer	PW127A	366.22
2000 x 600	Lino	PW126B	314.85
2000 x 700	Lino	PW127B	371.15
2000 x 600	MDF	PW126C	215.58
2000 x 700	MDF	PW127C	259.26

ACCESSORIES

L x W(mm)	Description	Code	£
1500 x 600	Base Shelf	PW156BS	58.12
1500 x 600	Base Shelf / Mat	PW156BM	89.82
1500 x 700	Base Shelf	PW157BS	61.49
1500 x 700	Base Shelf / Mat	PW157BM	94.63
2000 x 600	Base Shelf	PW126BS	65.98
2000 x 600	Base Shelf / Mat	PW126BM	109.51
2000 x 700	Base Shelf	PW127BS	70.56
2000 x 700	Base Shelf / Mat	PW127BM	118.18

CASTOR SET (Factory Fitted)

Set of 4x rubber tyred castors fitted.  
2x swivel & 2x swivel braked. (300Kg UDL capacity)

Diameter(mm)	Code	£
100	PW4SC	79.81

CABINETS

H / Drawer(mm)	Code	Shelves	Drawers	£
	PC1	1		210.93
150	PC2	1	1	258.73
150/100	PC4		3/1	422.95

DRAWERS

H(mm)	Drawers	Code	£
150	1	PD1A	160.53
350	1	PD1B	195.87
150/180	2	PD2	280.90

PREMIER UNDERBENCH CABINETS

650mm high, 500mm wide & 500mm deep. All cabinets secured by semi-flush fit locking handle and are complete with perforated tool panel and adjustable shelf.



PREMIER UNDERBENCH DRAWERS

500mm wide x 500mm deep.  
PD1A = 225mm high      PD1B = 425mm high  
All drawers are mounted on precision ball bearing telescopic slides (capacity 40kg UDL)



If not standard, please specify colour choice at time of order

PREMIER 1 WORKBENCH RANGE

Simple flat pack assembly for a basic bench 600mm wide including all assembly fixings



1500 x 600 c/w lino worktop  
PW156B

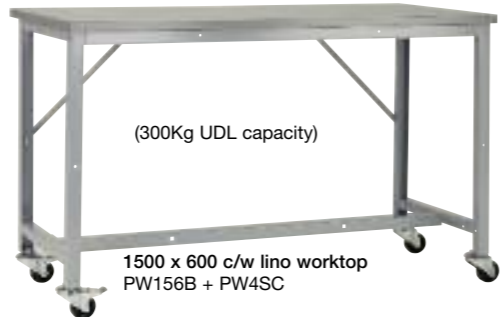

1500 x 600 c/w lino worktop  
PW156B + PW4SC



(300Kg UDL capacity)

1500 x 600 c/w lino worktop  
PW156B + PW156BM + PW4SC

All cabinets & drawers have central locking facility and are manufactured from 0.9mm thick steel sheet.

PREMIER 1 WORKBENCH RANGE



1500 x 600 c/w veneer worktop  
PW156A + PW156BM



1500 x 600 c/w veneer worktop  
PW156A + PC1



1500 x 600 c/w lino worktop  
PW156B + PC2

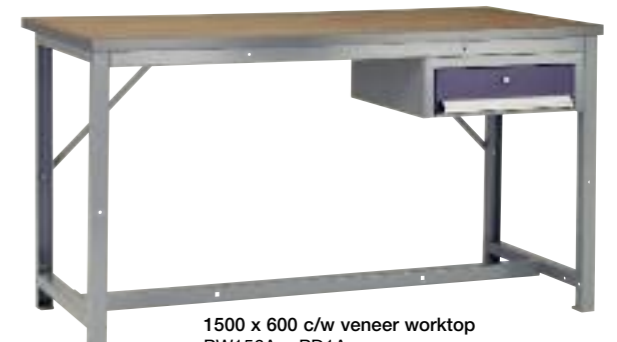

1500 x 600 c/w veneer worktop  
PW156A + PD1A



1500 x 600 c/w lino worktop  
PW156B + PC4



1500 x 600 c/w lino worktop  
PW156B + PD1A



1500 x 600 c/w lino worktop  
PW156B + PD2



1500 x 600 c/w veneer worktop  
PW156A + PD1A + PC1

400KG UDL

Construction from fabricated steel section with welded leg supports and multi position cross rail.



If not standard, please specify colour choice at time of order

PREMIER 2 WORKBENCH RANGE

A flat pack heavy duty modular workbench system with a weight capacity of 500kg UDL. All workbenches are 840mm high as standard, other heights available on request. All Premier workbench frames are epoxy polyester powder coated in Mid Grey RAL 7001. Cabinets/drawers Premier Blue.

WORKTOPS

- A = 25mm thick hardwood veneer top.
- B = 27mm thick industrial marble grey lino.
- C = 25mm thick plain cut MDF.

WORKBENCHES

L x W(mm)	Top	Code	£
1500 x 700	Veneer	PW257A	309.01
1500 x 700	Lino	PW257B	340.53
1500 x 700	MDF	PW257C	261.01
2000 x 700	Veneer	PW227A	382.50
2000 x 700	Lino	PW227B	383.12
2000 x 700	MDF	PW227C	284.52

CABINETS

H / Drawer(mm)	Code	Shelves	Drawers	£
150	PC1	1		210.93
150	PC2	1	1	258.73
150/100	PC4		3/1	422.95

DRAWERS

H(mm)	Drawers	Code	£
150	1	PD1A	160.53
350	1	PD1B	195.87
150	2	PD2	280.90

ACCESSORIES

ACCESSORY POSTS

PWAP1	1000mm high to accommodate combination back panel	£58.01
PWAP2	1500mm high to accommodate back panel and upper shelf	£62.60
PWAP3	2000mm high to accommodate back panel, upper shelf and light	£67.17

SERVICE DUCT

PWSD15	1500mm long service duct with 2 x 2 13amp double sockets	£86.20
PWSD20	2000mm long service duct with 2 x 2 13amp double sockets	£104.56

COMBINATION BACK PANELS 450MM HIGH

PWCP15	1500mm long back panel 1/2 louvred 1/2 perforated	£80.48
PWCP20	2000mm long back panel 1/2 louvred 1/2 perforated	£110.78

UPPER SHELVES

PWUSS15	1500mm long steel upper shelf	£69.13
PWUSS20	2000mm long steel upper shelf	£81.26

LIGHT BAR WITH 1200MM STRIP LIGHT\*

PWLU15	1500mm long supplied with diffuser	£118.63
PWLU20	2000mm long supplied with diffuser	£121.78

\*All electrics are supplied unwired, for fitting by a suitably qualified electrician

PREMIER 2 WORKBENCHES

HEIGHT

All workbenches 840mm high.

AVAILABLE IN 2 SIZES

1500mm length x 700mm wide  
2000mm length x 700mm wide

3 WORKTOPS

A = 27mm thick Veneer  
B = 27mm thick Lino  
C = 25mm thick plain cut MDF



1500 x 700 c/w lino worktop  
PW257B + PC2 + AP3 + SD15 + PWCP15 + USS15 + LU15



1500 x 700 c/w lino worktop  
PW257B + AP3 + SD15 + PWCP15 + USS15 + LU15

PREMIER UNDERBENCH CABINETS

650mm high, 500mm wide & 500mm deep.

All cabinets secured by semi-flush fit locking handle and are complete with perforated tool panel and adjustable shelf.



PC1

PC2

PC4

PREMIER UNDERBENCH DRAWERS

500mm wide x 500mm deep.

PD1A = 225mm high

PD1B = 425mm high

All drawers are mounted on precision ball bearing telescopic slides (capacity 40kg UDL)



PD1A

PD1B

PD2

WELDING WORKBENCH RANGE

A range of Flat Pack Heavy Duty Welding Workbench systems with a weight capacity of 500kg UDL. All workbenches are 840mm high as standard, other heights available on request.

PREMIER 2 TYPE WELDING BENCH  
1500 X 700 X 840 - PWB257FBSL



£478.31

Heavy Duty Framework designed to meet the toughest of environments.

Its rugged construction is well suited to industrial and educational use and is maintenance free.

Option 1 -1/2 refractory fire brick - 1/2 slatted worktop.

Flat pack - ideal for export.



1500 x 700 c/w lino worktop  
PW257B

PREMIER 2 TYPE WELDING BENCH  
1500 X 700 X 840 - PWB257FBST



1500 x 700 c/w lino worktop  
PW257B + PD1A + PC1

Heavy Duty Framework designed to meet the toughest of environments.

Option 1 -1/2 refractory fire brick - 1/2 steel worktop.

Flat pack - ideal for export.

£396.12



PREMIER 2 TYPE WELDING BENCH  
1500 X 700 X 840 - PWB257STSL



£360.49

Heavy Duty Framework designed to meet the toughest of environments.

Its rugged construction is well suited to industrial and educational use and is maintenance free.

Option 1 -1/2 steel - 1/2 slatted worktop.

Flat pack - ideal for export.



1500 x 700 c/w lino worktop  
PW257B + PC2



If not standard, please specify colour choice at time of order



If not standard, please specify colour choice at time of order



PREMIER 3 SQUARE TUBE & PREMIER 4 CANTILEVER WORKBENCHES

PREMIER 3 SQUARE TUBE & PREMIER 4 CANTILEVER WORKBENCHES

Welded construction from 30mm square steel tube (Premier 3) and 50mm x 25mm rectangular steel tube (Premier 4) with a choice of worktops & accessories. The benches will arrive on site built up with above the work surface accessories supplied loose. All workbenches are 840mm high as standard, other heights available. Mid Grey RAL 7001 Frames with Premier Blue Doors/Drawers.

PREMIER 3 WORKBENCH RANGE

PREMIER 3 WORKBENCHES (Square Tube)

L x W(mm)	Top	Code	£
1500 x 600	Veneer	PW356A	321.72
1500 x 750	Veneer	PW357A	370.02
1500 x 600	Lino	PW356B	344.76
1500 x 750	Lino	PW357B	365.10
1500 X 600	ESD	PW356G	385.19
1500 X 750	ESD	PW357G	469.60
1800 x 600	Veneer	PW386A	351.28
1800 x 750	Veneer	PW387A	367.61
1800 x 600	Lino	PW386B	344.91
1800 x 750	Lino	PW387B	363.82
1800 X 600	ESD	PW386G	461.66
1800 X 750	ESD	PW387G	480.44

PREMIER 4 WORKBENCHES (Cantilever)

L x W(mm)	Top	Code	£
1500 x 600	Veneer	PW456A	340.14
1500 x 750	Veneer	PW457A	401.29
1500 x 600	Lino	PW456B	352.23
1500 x 750	Lino	PW457B	402.45
1500 X 600	ESD	PW456G	417.53
1500 X 750	ESD	PW457G	482.23
1800 x 600	Veneer	PW486A	385.89
1800 x 750	Veneer	PW487A	388.22
1800 x 600	Lino	PW486B	383.28
1800 x 750	Lino	PW487B	402.21
1800 X 600	ESD	PW486G	483.03
1800 X 750	ESD	PW487G	491.72

CABINETS

H / Drawer(mm)	Code	Shelves	Drawers	£
	PC1	2		210.93
150	PC2	1	1	258.73
150/100	PC4		3/1	422.95

DRAWERS

H(mm)	Drawers	Code	£
150	1	PD1A	160.53
350	1	PD1B	195.87
150/180	2	PD2	280.90

PREMIER UNDERBENCH CABINETS

650mm high, 500mm wide & 500mm deep. All cabinets secured by semi-flush fit locking handle and are complete with perforated tool panel and adjustable shelf.



PREMIER UNDERBENCH DRAWERS

500mm wide x 500mm deep. PD1A = 225mm high PD1B = 425mm high All drawers are mounted on precision ball bearing telescopic slides (capacity 40kg UDL)



1800 x 750 c/w lino worktop PW387B + PC4

Key board monitor arm: £143.00



1800 x 750 c/w lino worktop PW387B + PC4 + PC2 + monitor arm



1800 x 750 c/w lino worktop PW387B + PC4 + PC2

PREMIER 4 WORKBENCH RANGE



1800 x 750 c/w ESD worktop PW487G



1800 x 750 c/w ESD worktop PW487G + PC2



1800 x 750 c/w ESD worktop PW487G + PC2 + PC4 + PSD18 + PAP1 + PCP18



1800 x 750 c/w ESD worktop PW487G + PC2 + PC4 + PSD18 + PAP3 + PCP18 + PUSS18 + PLU18

ACCESSORY POSTS

PAP1	1000mm high to accommodate combination back panel	£58.01
PAP2	1500mm high to accommodate back panel & upper shelf	£62.60
PAP3	2000mm high to accommodate back panel, upper shelf & light	£67.17

SERVICE DUCT\*

PSD15	1500mm long service duct with 2 x 2 13amp plug sockets	£70.15
PSD18	1800mm long service duct with 2 x 2 13amp plug sockets	£76.63

COMBINATION BACK PANELS 450MM HIGH

PCP15	1500mm long back panel louvred & perforated	£80.48
PCP18	1800mm long back panel louvred & perforated	£100.48

UPPER SHELVES

PUSS15	1500mm long steel upper shelf	£69.13
PUSS18	1800mm long steel upper shelf	£81.26

BASE SHELVES

PBS15	1500mm long steel base shelf	£73.28
PBS18	1800mm long steel base shelf	£79.37

LIGHT BAR WITH 1200MM STRIP LIGHT\*

PLU15	1500mm long supplied with diffuser	£106.76
PLU18	1800mm long supplied with diffuser	£113.89

\*All electrics are supplied unwired, for fitting by a suitably qualified electrician

WORKTOPS

A = 18mm thick hardwood veneer. 2mm veneer surface on 16mm composite core. Edge banded in 2mm thick grey plastic

B = 18mm thick industrial marble grey lino. 2mm veneer surface on 16mm composite core. Edge banded in 2mm thick grey plastic



If not standard, please specify colour choice at time of order



If not standard, please specify colour choice at time of order

ECONOMY 1 MEDIUM DUTY WORKBENCHES

Taking the Bedford Premier flat pack workbench frame and adding the standard Bedford underbench storage units makes for a quality yet economic workbench solution. Constructed from fabricated steel section with welded leg supports and multiposition cross rail. Framework powder coated Mid Grey RAL 7001 with Blue RAL 5015 doors and drawers front colour.

ECONOMY 1 MEDIUM DUTY WORKBENCHES

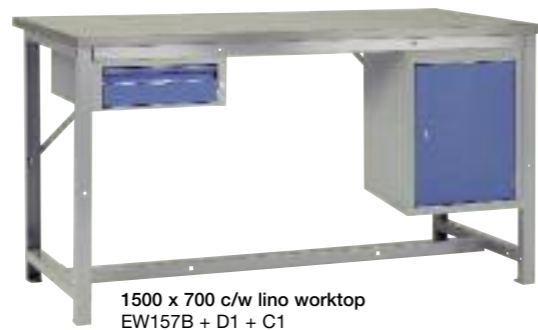

1500 x 700 c/w lino worktop  
EW157B + D1 + C1



1500 x 700 c/w MDF worktop  
EW157C



1500 x 700 c/w lino worktop  
EW157B + D1



1500 x 700 c/w lino worktop  
EW157B + C1

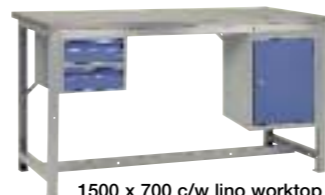

1500 x 700 c/w lino worktop  
EW157B + D2 + C1

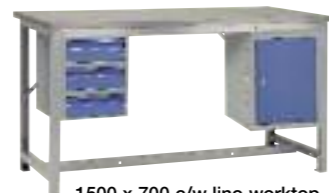

1500 x 700 c/w lino worktop  
EW157B + D3 + C1



1500 x 700 c/w lino worktop  
EW157B + CD1

WORKBENCHES

L x W(mm)	Top	Code	£
1500 x 700	Veneer	EW157A	299.80
1500 x 700	Lino	EW157B	331.32
1500 x 700	MDF	EW157C	248.66
2000 x 700	Veneer	EW127A	347.72
2000 x 700	Lino	EW127B	371.15
2000 x 700	MDF	EW127C	257.69

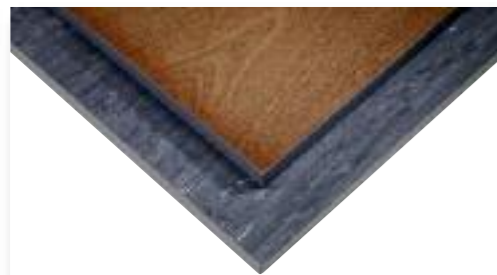

WORKTOPS

- A = 25mm thick hardwood veneer top.
- B = 27mm thick industrial marble grey lino.
- C = 25mm thick plain cut MDF.

DRAWERS & CABINETS

Description	Code	£
Single Drawer	D1	100.88
Double Drawer	D2	170.97
Triple Drawer	D3	238.37
Quad Drawer	D4	336.89
Cabinet Drawer	CD1	244.19
Cabinet	C1	124.30

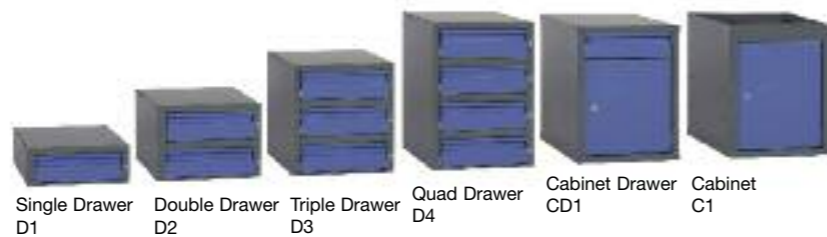

If not standard, please specify colour choice at time of order

ECONOMY 1 MOBILE MEDIUM DUTY WORKBENCHES

Take your workbench to the job with a mobile version of the economy workbench system.

ECONOMY 1 MOBILE MEDIUM DUTY WORKBENCHES



1500 x 700 c/w lino worktop  
EW157B + C1 + PW157BM + PW4SC

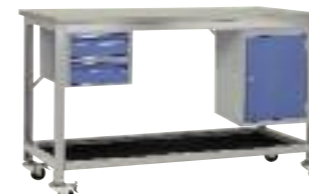

1500 x 700 c/w lino worktop  
EW157B + D2 + PW157BM + PW4SC



1500 x 700 c/w lino worktop  
EW157B + PW157BM + PW4SC

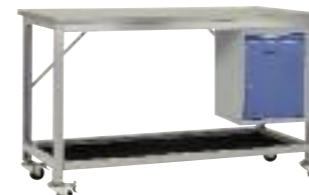

1500 x 700 c/w lino worktop  
EW157B + CD1 + PW157BM + PW4SC



1500 x 700 c/w lino worktop  
EW157B + D1 + C1 + PW157BM + PW4SC



1500 x 700 c/w lino worktop  
EW157B + D1 + PW157BM + PW4SC



1500 x 700 c/w lino worktop  
EW157B + D2 + PW157BM + PW4SC

BASE SHELVES

L x W(mm)	Description	Code	£
1500 x 700	Base Shelf	EW157BS	61.49
1500 x 700	Base Shelf/Mat	EW157BM	94.63
2000 x 700	Base Shelf	EW127BS	70.56
2000 x 700	Base Shelf/Mat	EW127BM	118.18

CASTORS (Factory Fitted)

Set of 4x rubber tyred castors fitted.  
2x swivel & 2x swivel braked. (300Kg UDL capacity)

Diameter(mm)	Code	£
100	PW4SC	79.81

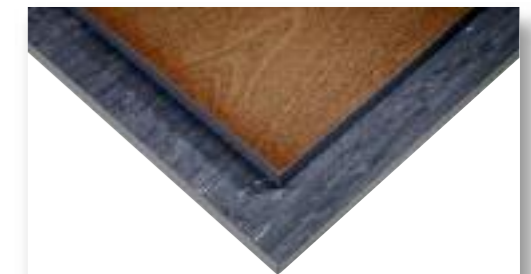

WORKTOPS

- A = 25mm thick hardwood veneer top.
- B = 27mm thick industrial marble grey lino.
- C = 25mm thick plain cut MDF.

DRAWERS & CABINETS

Description	Code	£
Single Drawer	D1	100.88
Double Drawer	D2	170.97
Triple Drawer	D3	238.37
Quad Drawer	D4	336.89
Cabinet Drawer	CD1	244.19
Cabinet	C1	124.30

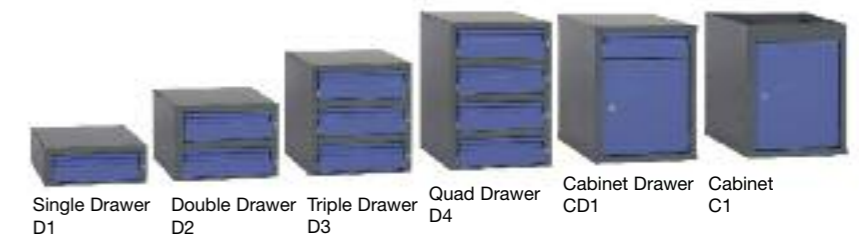

If not standard, please specify colour choice at time of order



## ECONOMY 2 HEAVY DUTY WORKBENCHES

Taking the Bedford Premier 2 heavy duty flat pack workbench frame and adding the standard Bedford underbench storage units makes for a quality yet economic workbench solution with a weight capacity of 500kg UDL. Framework powder coated Mid Grey RAL 7001 with a Blue RAL 5015 door and drawer.

### WORKTOPS

- A = 25mm thick hardwood veneer top.
- B = 27mm thick industrial marble grey lino.
- C = 25mm thick plain cut MDF.

### WORKBENCHES

L x W(mm)	Top	Code	£
1500 x 700	Veneer	EW257A	309.01
1500 x 700	Lino	EW257B	340.53
1500 x 700	MDF	EW257C	261.01
2000 x 700	Veneer	EW227A	382.50
2000 x 700	Lino	EW227B	381.69
2000 x 700	MDF	EW227C	284.52

### ACCESSORIES

#### ACCESSORY POSTS

EWAP1	1000mm high to accommodate combination back panel	£58.01
EWAP2	1500mm high to accommodate back panel and upper shelf	£62.60
EWAP3	2000mm high to accommodate back panel, upper shelf and light	£67.17

#### SERVICE DUCT

EWSD15	1500mm long service duct with 2 x 2 13amp double sockets	£86.99
EWSD20	2000mm long service duct with 2 x 2 13amp double sockets	£104.56

#### COMBINATION BACK PANELS 450MM HIGH

EWCP15	1500mm long back panel 1/2 louvred 1/2 perforated	£80.48
EWCP20	2000mm long back panel 1/2 louvred 1/2 perforated	£110.78

#### UPPER SHELVES

EWUSS15	1500mm long steel upper shelf	£69.13
EWUSS20	2000mm long steel upper shelf	£81.26

#### LIGHT BAR WITH 1200MM STRIP LIGHT\*

EWL15	1500mm long supplied with diffuser	£118.63
EWL20	2000mm long supplied with diffuser	£121.78

\*All electrics are supplied unwired, for fitting by a suitably qualified electrician

### ECONOMY 2 HEAVY DUTY WORKBENCHES

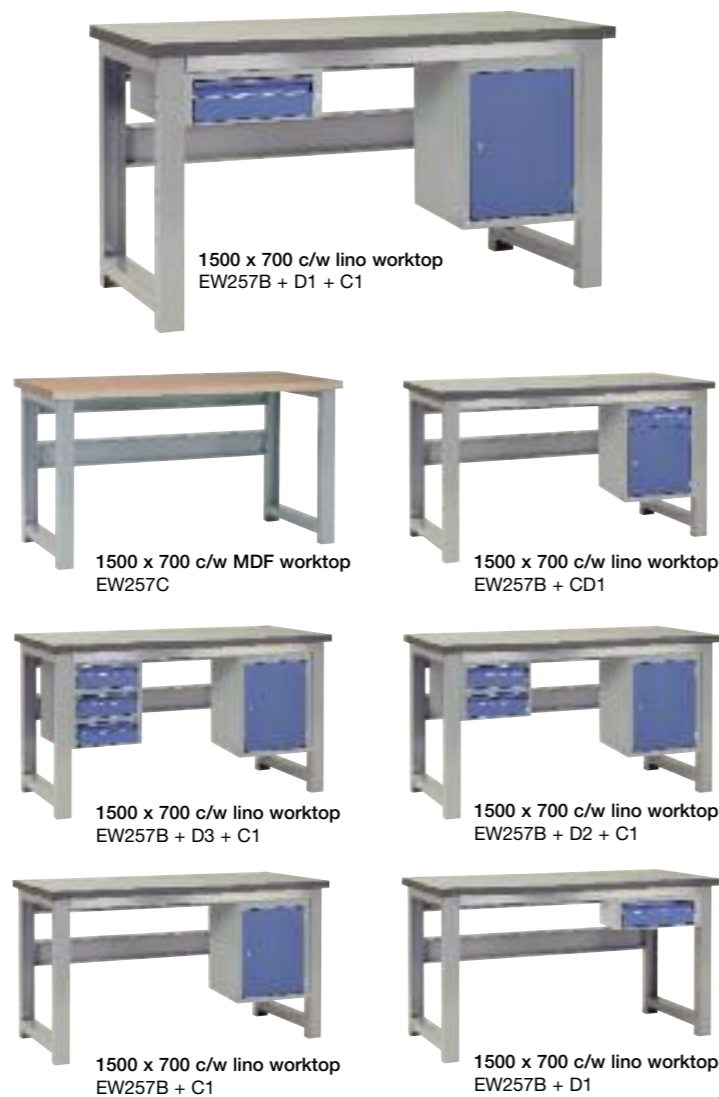

Workstation Kits  
see side panel for info & pricing



Configuration Kits  
see side panel for info & pricing



EPA Super Kits  
see side panel for info & pricing

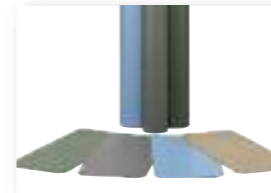

Bench Coverings  
see side panel for info & pricing



Bench-Saver Mats  
see side panel for info & pricing

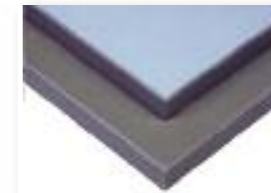

A/S Rubber Worktops  
see side panel for info & pricing



ESD Laminate Worktops  
see side panel for info & pricing



Mat Ground Cord (3m)  
BED-CW-60358



Push & Clinch Snap Socket  
BED-CW-800008



Universal Snap Kit  
BED-CW-80014



Wrist Straps  
see side panel for info & pricing



Leads  
see side panel for info & pricing



Wrist Band  
BED-WE-AY



Adaptor  
BED-ADP4BP10



Male Press Studs (Screw - pk10)  
BED-PSM-10S



Male Press Studs (Punch - pk10)  
BED-PSM-10



Earth Bonding Point Box  
BED-BLB-43



Earth Bonding Plate (Press Stud)  
BED-EBB-10



Earth Bonding Plate (2BA Terminal)  
BED-EFB-T



Earth Grounding Label  
BED-GPL-3636



Earth Bonding Label  
BED-BPL-3636

## ESD WORKBENCH ACCESSORIES

### WORKSTATION KITS

L x W(mm)	Code	£
1200 x 600	BED-WSK1-1206	P.O.A
1500 x 600	BED-WSK1-1506	P.O.A
1800 x 600	BED-WSK1-1806	P.O.A

### CONFIGURATION KITS

L x W(mm)	Code	£
300 x 200	BED-FCC-0302	P.O.A
400 x 300	BED-FCC-0403	P.O.A

### EPA SUPER KITS

L x W(mm)	Code	£
1200 x 600	BED-ESK-1206	P.O.A
1500 x 600	BED-ESK-1506	P.O.A
1800 x 600	BED-ESK-1806	P.O.A

### NEOSTAT C2 FLEXIBLE MATTING

L x W(mm)	Code	£
1200 x 600	BED-BMC2-1206	P.O.A
1500 x 600	BED-BMC2-1506	P.O.A
1800 x 600	BED-BMC2-1806	P.O.A

### NEOSTAT C2 ROLLS

L x W(mm)	Code	£
10m x 1000	BED-BMC2-ROLL1000	P.O.A
10m x 1200	BED-BMC2-ROLL1200	P.O.A

### BENCH SAVER MATS

L x W(mm)	Code	£
250 x 200	BED-BSC2-0202	P.O.A
700 x 300	BED-BSC2-0703	P.O.A

### ESD WORKTOPS

L x W(mm)	Code	£
1200 x 600	BED-RTN-1206	P.O.A
1200 x 750	BED-RTN-1207	P.O.A
1200 x 900	BED-RTN-1209	P.O.A
1500 x 600	BED-RTN-1506	P.O.A
1500 x 750	BED-RTN-1507	P.O.A
1500 x 900	BED-RTN-1509	P.O.A
1800 x 600	BED-RTN-1806	P.O.A
1800 x 750	BED-RTN-1807	P.O.A
1800 x 900	BED-RTN-1809	P.O.A

please suffix order code for worktop option with:  
G = Grey Rubber - B = Blue Rubber - L = Laminate

### WRIST STRAP (WITH 4MM BANANA PLUG)

L (mm)	Code	£
N/A	BED-WEE-201041Y	P.O.A

### WRIST STRAP (WITH 10MM PRESS STUD)

L (mm)	Code	£
N/A	BED-WEE-2010101Y	P.O.A

### LEADS (WITH 4MM BANANA PLUG)

L (mm)	Code	£
N/A	BED-E-201041Y	P.O.A

### LEADS (WITH 10MM PRESS STUD)

L (mm)	Code	£
N/A	BED-E-2010101Y	P.O.A



If not standard, please specify colour choice at time of order

INFINITE WORKBENCH SYSTEM 1000KG UDL

INFINITE WORKBENCH SYSTEM 1000KG UDL

INFINITE SYSTEM

Start with a 2M or 3M starter workbench and simply use add-on workbenches and accessories as required.

STRENGTH & FLEXIBILITY

Framework is constructed from fabricated steel section with welded leg supports and bolt in multi-position cross rails, which can be assembled in a variety of combinations to suit individual applications. Steel work powder coated Dark Grey (RAL 7031).

CONVENIENCE

Each bench is supplied in flat pack form, the larger units having sectional worktops, the larger units having sectional worktops for ease of handling. Available in 2 lengths, 3 depths, and 3 worktop options.

ECONOMIC

This system offers great economic advantages over standard workbench sizes e.g. the 3000mm x 1200mm workbench (opposite) is the equivalent working area of 4 x 1500mm x 600mm workbenches.

BENCHES (25MM MDF WORKTOP)

All benches are 840mm high as standard.

L x W(mm)	Description	Code	£
2000 x 700	Starter	KDB2078A	355.54
2000 x 700	Starter & Base	KDB2078BSA	422.14
2000 x 1200	Starter	KDB2028A	453.92
2000 x 1200	Starter & Base	KDB2028BSA	553.64
2000 x 1400	Starter	KDB2048A	495.80
2000 x 1400	Starter & Base	KDB2048BSA	635.39
3000 x 700	Starter	KDB3078A	572.92
3000 x 700	Starter & Base	KDB3078BSA	655.55
3000 x 1200	Starter	KDB3028A	705.13
3000 x 1200	Starter & Base	KDB3028BSA	799.89
3000 x 1400	Starter	KDB3048A	802.08
3000 x 1400	Starter & Base	KDB3048BSA	1,018.03
2000 x 700	Add-On	KDA278A	297.09
2000 x 700	Add-On & Base	KDA278BSA	370.19
2000 x 1200	Add-On	KDA228A	383.43
2000 x 1200	Add-On & Base	KDA228BSA	481.84
2000 x 1400	Add-On	KDA248A	424.55
2000 x 1400	Add-On & Base	KDA248BSA	566.21

BENCHES (30MM VENEER WORKTOP)

All benches are 840mm high as standard.

L x W(mm)	Description	Code	£
2000 x 700	Starter	KDB2078B	431.22
2000 x 700	Starter & Base	KDB2078BSB	498.56
2000 x 1200	Starter	KDB2028B	504.99
2000 x 1200	Starter & Base	KDB2028BSB	616.46
2000 x 1400	Starter	KDB2048B	625.66
2000 x 1400	Starter & Base	KDB2048BSB	730.80
3000 x 700	Starter	KDB3078B	680.88
3000 x 700	Starter & Base	KDB3078BSB	763.39
3000 x 1200	Starter	KDB3028B	879.21
3000 x 1200	Starter & Base	KDB3028BSB	973.95
3000 x 1400	Starter	KDB3048B	1,026.85
3000 x 1400	Starter & Base	KDB3048BSB	1,242.79
2000 x 700	Add-On	KDA278B	383.23
2000 x 700	Add-On & Base	KDA278BSB	444.20
2000 x 1200	Add-On	KDA228B	446.73
2000 x 1200	Add-On & Base	KDA228BSB	545.92
2000 x 1400	Add-On	KDA248B	563.72
2000 x 1400	Add-On & Base	KDA248BSB	659.22

BENCHES (30MM LINO WORKTOP)

All benches are 840mm high as standard.

L x W(mm)	Description	Code	£
2000 x 700	Starter	KDB2078C	450.61
2000 x 700	Starter & Base	KDB2078BSC	517.29
2000 x 1200	Starter	KDB2028C	604.38
2000 x 1200	Starter & Base	KDB2028BSC	679.99
2000 x 1400	Starter	KDB2048C	637.04
2000 x 1400	Starter & Base	KDB2048BSC	808.55
3000 x 700	Starter	KDB3078C	687.99
3000 x 700	Starter & Base	KDB3078BSC	807.94
3000 x 1200	Starter	KDB3028C	976.49
3000 x 1200	Starter & Base	KDB3028BSC	1,097.45
3000 x 1400	Starter	KDB3048C	1,282.81
3000 x 1400	Starter & Base	KDB3048BSC	1,436.55
2000 x 700	Add-On	KDA278C	465.75
2000 x 700	Add-On & Base	KDA278BSC	514.54
2000 x 1200	Add-On	KDA228C	577.20
2000 x 1200	Add-On & Base	KDA228BSC	608.47
2000 x 1400	Add-On	KDA248C	580.75
2000 x 1400	Add-On & Base	KDA248BSC	736.35



2000 x 1400 Starter workbench with MDF worktop & upper shelf unit  
Order code: KDB2048A + PICTURED ACCESSORIES  
USS235 2000mm Upper Shelf

Certain benches within the range are designed to accommodate two or more persons working together. With this in mind the upper shelf unit is accessible from both sides.

CREATE A RUN

Using the starter & extension method you can mix and match depths.



- HEAVY DUTY MODULAR DESIGN
- STARTER & ADD-ON BENCHES
- HEIGHT ADJUSTABLE FROM 840-940MM IN 25MM INCREMENTS
- EASY TO ADD ACCESSORIES



2000 x 700 Starter workbench with MDF worktop, MDF base shelf, cabinet, triple drawer & leg socket  
Order code: KDB2078BSA +C1 +D3 +LS1



3000 x 1200 Starter workbench with MDF worktop, MDF base shelf and combined cabinet & drawer unit  
Order code: KDB3028BSA + CD1



3000 x 1200 Starter workbench with MDF worktop and MDF base shelf  
Order code: KDB3028BSA



3000 x 1200 Starter workbench with MDF worktop  
Order code: KDB3028A

ACCESSORIES

Description	Code	£
Cupboard Unit	C1	124.30
Single Drawer	D1	100.88
Two Drawer	D2	170.97
Three Drawer	D3	238.37
Quad Drawer	D4	336.89
Cabinet Drawer	CD1	244.19
13 Amp Socket	LS1	22.74
2000mm Tool Rail	TR20	122.82
2000mm Light & Tool Rail	LTR20	218.61
2000mm Upper Shelf	USS235	158.58
3000mm Upper Shelf	USS335	273.04
2000mm Service Duct	SD20	151.00
3000mm Service Duct (2x1500)	SD30	199.05

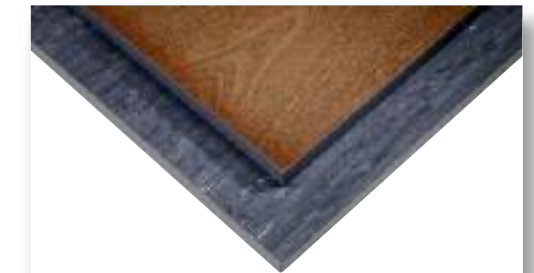

WORKTOPS

A = 25mm thick hardwood veneer top. 2mm veneer surface on composite core. Edge banded in 2mm thick grey plastic

B = 27mm thick industrial marble grey lino. 2mm vinyl surface on composite core. Edge banded in 2mm thick grey plastic.

C = 25mm thick plain cut MDF

All base shelves are 18mm thick plain cut MDF



13 Amp Socket  
Order code: LS1



Pre-punched to accommodate pipe work



If not standard, please specify colour choice at time of order



MEDIUM DUTY SQUARE TUBE WORKBENCHES 45F

The Flexistation workbench system is ideal for light assembly work or a production run. These benches arrive on site built up with above the work surface accessories supplied loose. All workbenches are 840mm high as standard, other heights are available. Frames Mid Grey 7001, Doors/Drawers Blue 5015 as standard.



**1800 x 750 Laminate worktop**  
square tube workbench  
Order code: 45F187C +

- PICTURED ACCESSORIES**
- D3 Triple drawer
  - C1 Cabinet
  - AP1 Accessory posts
  - LP18 Louvered Panel

**SECURITY STORAGE**  
Lockable storage cabinets and drawers to encourage an efficient workstation and workplace.

**ADJUSTABLE FEET**  
Adjustable feet available to correct uneven floors



**ESD**  
Worktop options G



**1800 x 750 c/w Laminate worktop**  
Square Tube Workbench with Single Drawer & Cabinet  
45F187C + D3 + C1



**1800 x 750 c/w Laminate worktop**  
Square Tube Workbench with under bench cabinet  
45F187C + C1



**1800 x 750 c/w Laminate worktop**  
Square Tube Workbench  
45F187C

**MD WORKTOPS**

- A = 1.5mm Steel on composite core
- B = 1.5mm Stainless steel on composite core
- C = 18mm Laminate
- D = 18mm Lino
- E = 24mm Plywood
- F = 24mm MDF
- G = 18mm ESD Laminate



If not standard, please specify colour choice at time of order

SIZES		ORDER CODE								
L(mm)	W(mm)	Basic Benches*	A £	B £	C £	D £	E £	F £	G £	
1200	600	45F126*	358.15	412.38	272.92	333.41	317.56	248.41	356.34	
1200	750	45F127*	399.15	439.85	311.14	346.07	336.80	258.43	384.01	
1200	900	45F129*	377.76	446.10	333.45	367.87	356.13	268.62	416.18	
1500	600	45F156*	389.66	464.47	312.27	344.76	404.15	258.36	385.19	
1500	750	45F157*	402.78	488.51	328.65	365.10	414.55	277.28	469.60	
1500	900	45F159*	408.76	471.51	362.42	404.77	416.05	278.98	480.32	
1800	600	45F186*	404.20	456.88	321.75	344.91	355.83	295.23	461.66	
1800	750	45F187*	415.25	476.43	326.06	363.82	412.38	296.92	480.44	
1800	900	45F189*	420.98	502.45	366.39	415.16	406.00	299.42	530.20	

\*choose a worktop and add A, B, C, D, E, F, G

MEDIUM DUTY CANTILEVER WORKBENCHES 46M

The Maxistation workbench system is ideal for light assembly work or a production run. These benches are designed to optimise space under the work surface, especially when used by seated operators. All workbenches are 840mm high as standard, other heights are available. Frames Mid Grey RAL 7001, Doors/Drawers Blue RAL 5015 as standard.



**1800 x 750 ESD Laminate worktop**  
square tube workbench  
Order code: 46M187G +

- PICTURED ACCESSORIES**
- D3 Triple drawer
  - CP18 Combination panel
  - SD18 Sloping fronted rear service duct unwired
  - AP3 Accessory posts
  - USS18 Upper shelf
  - LU18 Light bar

**SECURITY STORAGE**  
Lockable storage cabinets and drawers to encourage an efficient workstation and workplace.

**ADJUSTABLE FEET**  
Adjustable feet available to correct uneven floors



**ESD**  
Worktop options G



**1800 x 750 c/w Laminate worktop**  
Cantilever Workbench  
46M187C



**1800 x 750 c/w Laminate worktop**  
Cantilever Workbench with sloping fronted service duct unwired  
46M187C + SD18

**MD WORKTOPS**

- A = 1.5mm Steel on composite core
- B = 1.5mm Stainless steel on composite core
- C = 18mm Laminate
- D = 18mm Lino
- E = 24mm Plywood
- F = 24mm MDF
- G = 18mm ESD Laminate



If not standard, please specify colour choice at time of order

SIZES		ORDER CODE								
L(mm)	W(mm)	Basic Benches*	A £	B £	C £	D £	E £	F £	G £	
1200	600	46M126*	388.42	462.16	312.15	370.98	352.19	284.03	388.19	
1200	750	46M127*	399.89	466.02	352.82	387.89	370.59	297.09	401.44	
1200	900	46M129*	408.13	469.87	375.66	409.21	389.06	306.28	461.84	
1500	600	46M156*	420.02	496.72	352.89	352.23	434.99	303.98	417.53	
1500	750	46M157*	432.62	499.86	370.64	402.45	444.97	317.44	482.23	
1500	900	46M159*	438.34	503.00	404.41	445.30	447.43	320.57	503.34	
1800	600	46M186*	444.55	511.99	361.55	383.28	389.38	317.57	483.04	
1800	750	46M187*	434.00	515.13	368.00	402.21	442.89	327.33	491.72	
1800	900	46M189*	444.55	518.27	408.24	455.46	437.31	330.47	579.75	

\*choose a worktop and add A, B, C, D, E, F, G, denoting which you require.

WORKBENCH ACCESSORIES

A comprehensive range of accessories for storage above and below the work surface. Workbench accessories are factory fitted and not for retro-fit. Above worksurface accessories are supplied detached for transportation purposes.



BASE SHELVES

Code	Length(mm)	£
BS12	1200	63.84
BS15	1500	74.94
BS18	1800	79.17

Base shelves are 1.2mm thick steel sheet



DRAWERS - 25KG UDL

Code	Description	£
D1	Single drawer	100.88
D2	Double drawer	170.97
D3	Triple drawer	238.37
D4	Quad drawer	336.89
C1*	Cabinet: C1 Cabinet Size - External D450 x W450 x H600mm	124.30
CD1*	Cabinet drawer: CD1 Cabinet Size - External D450 x W450 x H600mm Drawer Size - Internal D420 x W355 x H100mm	244.19

\*Includes shelf

CASTORS

Code	Description	£
C100	x 4 100mm	79.81



100MM RETAINING LIP THREE SIDES

Code	Description	£
SL12	Retaining lip	50.49
SL15	Retaining lip	51.43
SL18	Retaining lip	66.66



MONITOR ARM

Code	Description	£
KBMA1	Keyboard monitor arm	143.00



ELECTRICS

Sloping fronted rear service duct unwired

Code	Length(mm)	£
SD12	1200	67.17
SD15	1500	71.51
SD18	1800	75.44

Supplied unwired, for fitting by a suitably qualified electrician.



ACCESSORY POSTS

Code	Height(mm)	£
AP1	1000	59.33
AP2	1500	64.06
AP3	2000	75.81

Adjustable and supplied in pairs.



LOUVRE PANELS†

Code	Length(mm)	£
LP12	1200	67.59
LP15	1500	82.31
LP18	1800	102.75



PERFORATED PANELS†

Code	Length(mm)	£
TP12	1200	67.59
TP15	1500	82.31
TP18	1800	102.75



UPPER SHELVES††

Code	Length(mm)	£
USS12*	1200	60.13
USS15*	1500	68.03
USS18*	1800	79.88

\*Upper shelves are 2mm thick steel. Laminate & MDF also available.



LIGHT BARS†††

Code	Length(mm)	£
LU12	1200	138.06
LU15	1500	140.49
LU18	1800	148.98

Supplied unwired, for fitting by electrician.

LOUVRED CATEGORY 2 LIGHT BARS†††

Code	Length(mm)	£
CU12	1200	187.26
CU15	1500	188.26
CU18	1800	189.60

Supplied unwired, for fitting by electrician.



VICE PLATE

Code	Description	£
VP	Vice plate	26.06

VICES INC. VICE PLATE

BV75VP	75mm Engineers	73.40
BV15VP	150mm Engineers	150.68



PLASTIC BINS (Per Pack)

Code	L	W	D(mm)	£	QTY
BB2	165	100	75	POA	20
BB3	240	150	125	POA	10
BB4	355	220	125	POA	10
BB5	355	200	175	POA	10

WORKBENCH OPTIONS

Medium & heavy duty workbenches are available in the following options, please add:

Code	Description	£
SDC	Sliding Door	495.00
FP	Flat Pack	49.95

†ACCESSORY POSTS REQUIRED

† AP1 Required  
 †† AP2 Required  
 ††† AP3 Required



Accessories page 31



If not standard, please specify colour choice at time of order

MEDIUM & HEAVY DUTY WORKBENCHES

A comprehensive range of fully welded angle iron construction workbenches with a variety of worktop options and accessories. All workbenches are 840mm high as standard, other heights available. Popular models - available in all sizes from 1200mm long x 600mm wide to 1800mm long x 900mm wide. Frames Mid Grey RAL 7001, Doors/Drawers Blue RAL 5015 as standard.



1800 x 750 c/w  
Laminate worktop

Order code MD: 40187C +

PICTURED ACCESSORIES

- D1 Single drawer
- C1 Cabinet
- SD18 Sloping fronted rear service duct unwired
- AP3 Accessory posts
- LP18 Louvre panel
- USS18 Upper shelf
- LU18 Light bar



1800 x 750 c/w MDF worktop  
MD: 40187F + BS18  
HD: 44187A + BS18



1800 x 750 c/w MDF worktop  
MD: 40187F + BS18 + D2 + C1  
HD: 44187A + BS18 + D2 + C1



1800 x 750 c/w steel top  
MD: 38187 + BS18 + D1 + C1 + SL18  
HD: 42187 + BS18 + D1 + C1 + SL18



ESD  
Worktop options G



1800 x 750 c/w Steel worktop  
MD: 38187 + C1 + D3  
HD: 42187 + C1 + D3

1800 x 750 c/w Steel worktop  
MD: SDC 38187  
HD: SDC 42187



MEDIUM DUTY WORKBENCHES (500KG UDL)

Welded construction from 40 x 40 x 4mm angle iron with 2 pairs of leg supports with single bottom mounted cross rail.

SIZES L(mm)	W(mm)	ORDER CODES		ORDER CODES							
		2mm Steel Top £	Wood Top* £	A £	B £	C £	D £	E £	F £	G £	
1200	600	38126	250.07	40126*	388.42	433.82	290.48	321.47	332.36	288.87	356.58
1200	750	38127	253.36	40127*	388.24	464.86	291.19	337.77	345.78	298.73	369.50
1200	900	38129	257.06	40129*	408.69	480.00	323.33	368.29	369.48	308.59	426.73
1500	600	38156	257.69	40156*	420.08	493.78	297.72	377.22	366.96	300.00	378.17
1500	750	38157	267.52	40157*	432.62	506.85	321.79	391.33	436.79	311.81	456.17
1500	900	38159	277.36	40159*	438.34	516.78	367.27	410.84	440.66	317.76	461.90
1800	600	38186	275.17	40186*	444.55	500.53	328.06	380.12	385.42	318.46	475.91
1800	750	38187	286.41	40187*	434.00	513.24	336.06	403.19	444.42	323.15	475.91
1800	900	38189	297.65	40189*	444.55	530.12	374.10	432.50	448.33	337.95	541.32

HEAVY DUTY WORKBENCHES (1000KG UDL)

Welded construction from 50 x 50 x 5mm angle iron with 2 pairs of leg supports with single bottom mounted cross rail.

SIZES L(mm)	W(mm)	ORDER CODES		ORDER CODES				
		3mm Steel Top £	Wood Top* £	A £	B £	C £	D £	
1200	600	42126	276.95	44126*	305.87	346.63	358.31	P.O.A
1200	750	42127	288.94	44127*	317.22	362.38	387.73	P.O.A
1200	900	42129	310.16	44129*	328.81	388.02	439.83	P.O.A
1500	600	42156	298.03	44156*	320.24	382.44	441.31	P.O.A
1500	750	42157	312.05	44157*	332.92	454.31	496.94	P.O.A
1500	900	42159	326.06	44159*	344.57	461.09	500.85	P.O.A
1800	600	42186	327.07	44186*	332.97	394.09	441.32	P.O.A
1800	750	42187	343.10	44187*	343.72	462.67	515.32	P.O.A
1800	900	42189	359.08	44189*	361.87	470.42	519.22	P.O.A

MD WORKTOPS

- A = 1.5mm Steel on composite core
- B = 1.5mm Stainless steel on composite core
- C = 18mm Laminate
- D = 18mm Lino
- E = 24mm Plywood
- F = 24mm MDF
- G = 18mm ESD Laminate

HD WORKTOPS

- 3mm Steel
- A = 24mm MDF
- B = 24mm Plywood
- C = 36mm Plywood
- D = 30mm Beech Hardwood

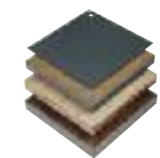

If not standard, please specify colour choice at time of order